

See page 2
4
5 (shorts)
10 Pwr. Ed.
19 Pass selected w Voltages

Devil Riders

on page 4 16.5AC is actually way high



FLIPPERSPILL.COM

ELECTRICAL DIAGRAMS

ZACCARIA®

LIST OF ILLUSTRATIONS

JUMP LIST FOR MEMORIES SELECTION

BLOCK DIAGRAM

ASSEMBLY DRAWING

POWER WIRING

LAYOUT }
 DIAGRAM } CPU

LAYOUT }
 DIAGRAM } INTERFACE

LAYOUT }
 DIAGRAM } POWER

LAYOUT }
 DIAGRAM } DRIVER DISPLAY

LAYOUT }
 DIAGRAM } SOUND & SPEECH

PLAYFIELD CONTACTS WIRING

COIL WIRING

PLAYFIELD & HEAD LAMPS WIRING

CABINET & FRONT DOOR WIRING

POWER SUPPLY

COLOR CODE

WIRES CUTAWAY
 VIEW LIST

Black	0	mm ² 0,22	/1
Brown	1	mm ² 0,35	/2
Red	2	mm ² 0,5	/3
Orange	3	mm ² 0,9	/4
Yellow	4	mm ² 1,5	/5
Green	5		
Blue	6		
Violet	7		
Grey	8		
White	9		
Pink	11		
Light Blue	12		

CN10 PIN 7

CN10 PIN 13

CNJ6

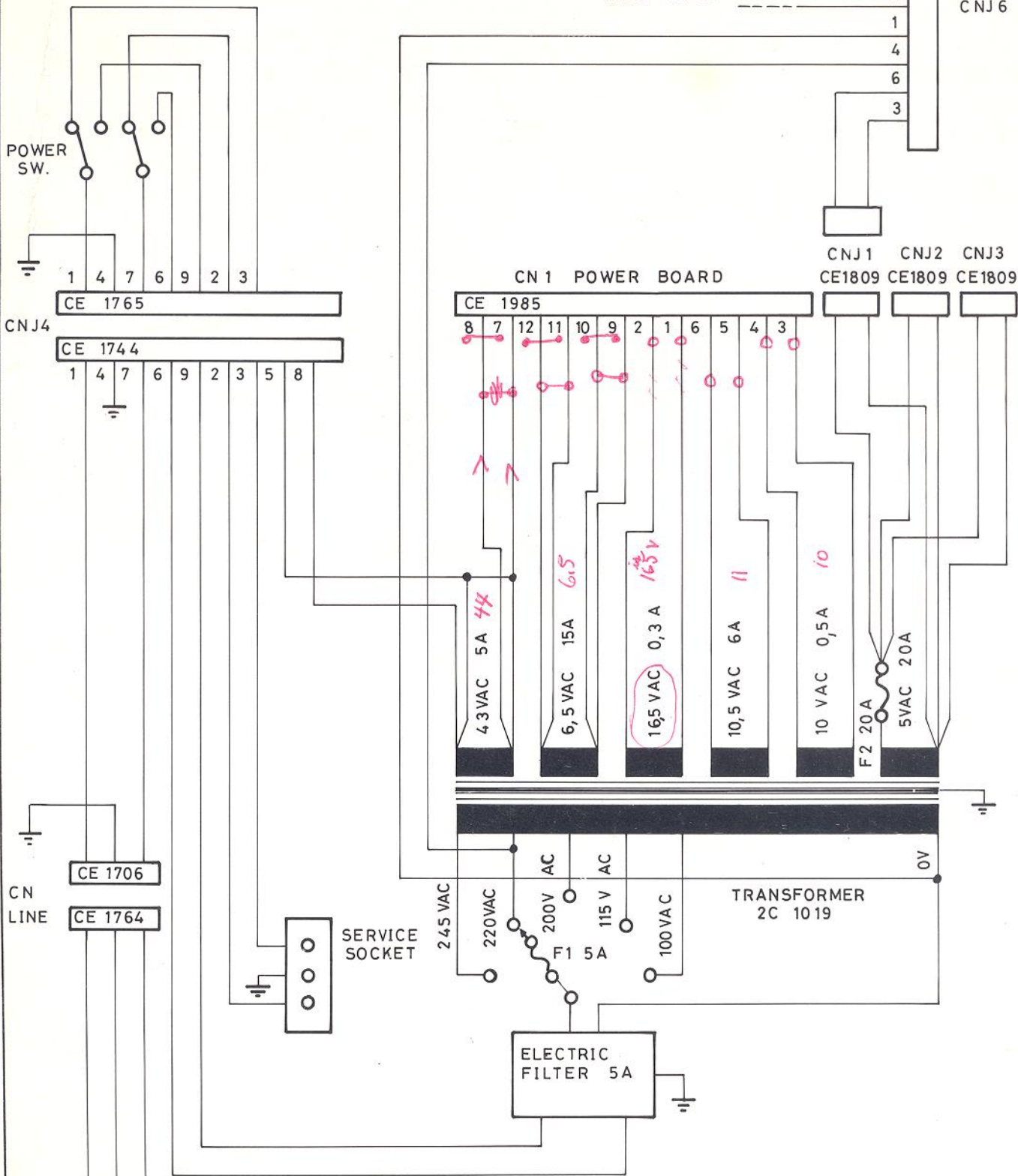



F.LLI ZACCARIA s.n.c.

Via Armaroli, 15 - 40012 CALDERARA DI RENO (Bo) ITALY

Codice	Descrizione			
	TELAIO ALIMENTAZIONI "DEVIL RIDERS"			
Codice Gruppo	Dis.	Data	Rev.	Data Rev.
CEC 286	lorema	24.10.83		
Materiale	Trattamento		Scala	
note				Foglio

ELECTRIC WIER

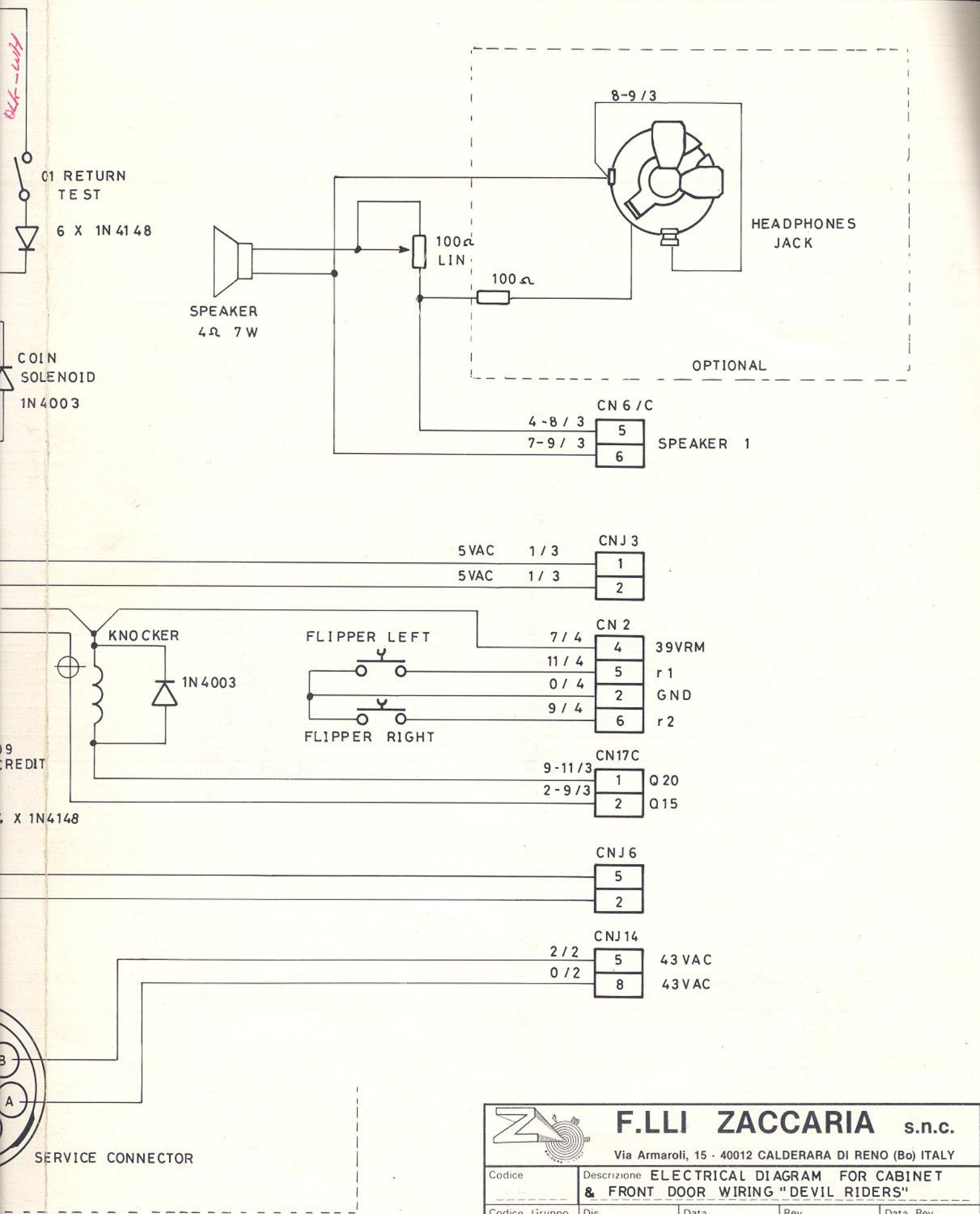

F.LLI ZACCARIA s.n.c.

Via Armaroli, 15 - 40012 CALDERARA DI RENO (Bo) ITALY

Codice	Descrizione ELECTRICAL DIAGRAM FOR CABINET & FRONT DOOR WIRING "DEVIL RIDERS"			
Codice Gruppo	Dis. <i>LOVEM2</i>	Data 24.10.83	Rev.	Data Rev.
Materiale		Trattamento		Scala
note :				Foglio

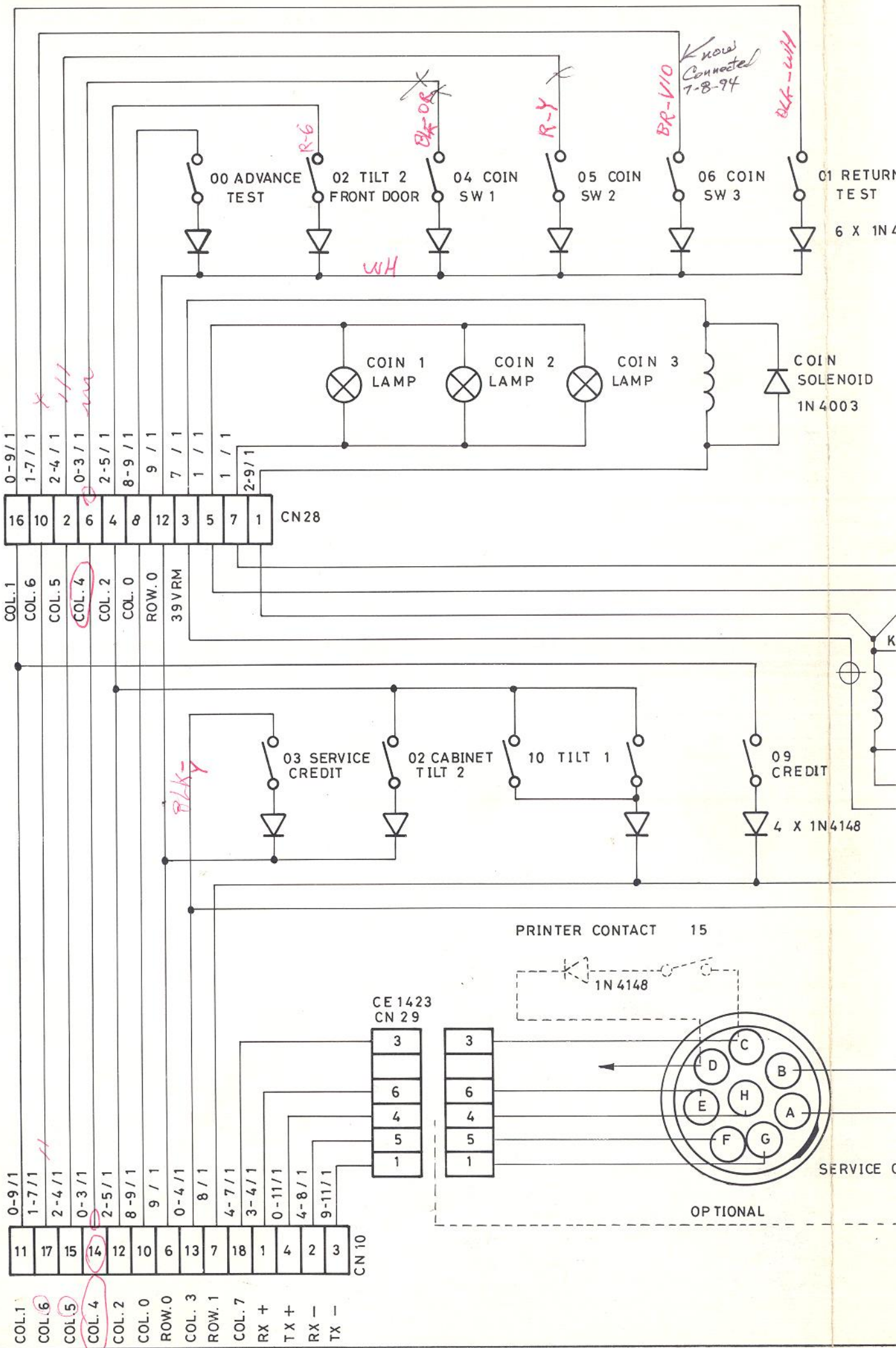

HEAD LAMPS

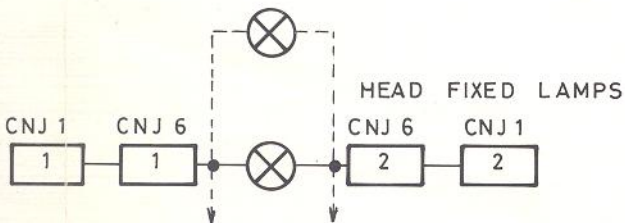
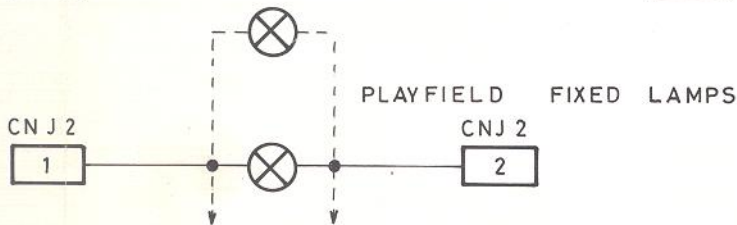
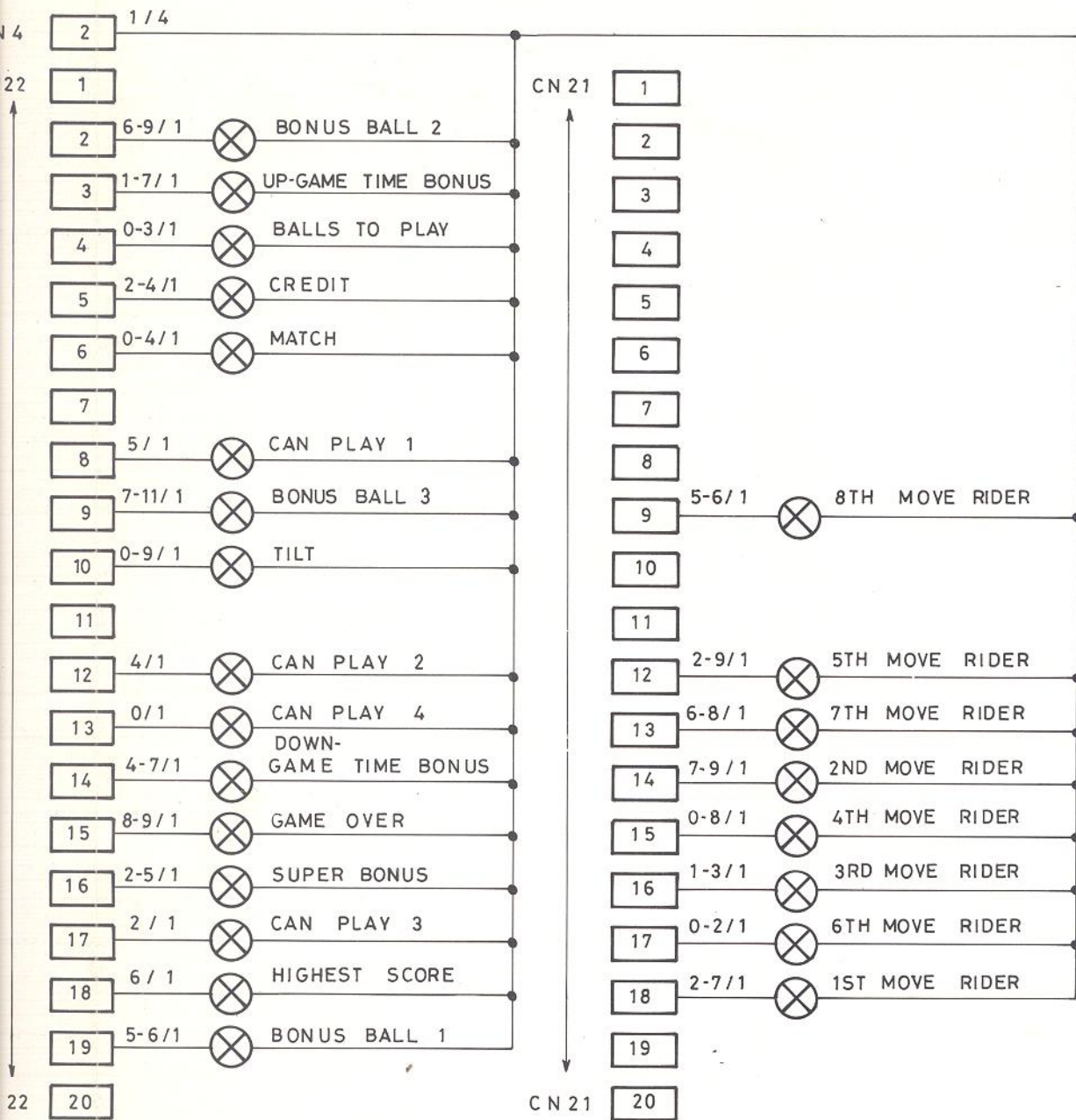

F.LLI ZACCARIA s.n.c.

Via Armadori, 15 - 40012 CALDERARA DI RENO (Bo) ITALY

Codice	Descrizione ELECTRICAL DIAGRAM FOR PLAYFIELD & HEAD LAMPS "DEVIL RIDERS"			
Codice Gruppo	Dis. <i>lorenz</i>	Data 06.12.83	Rev.	Data Rev.
Materiale		Trattamento		Scala
note :				Foglio

PLAYFIELD LAMPS

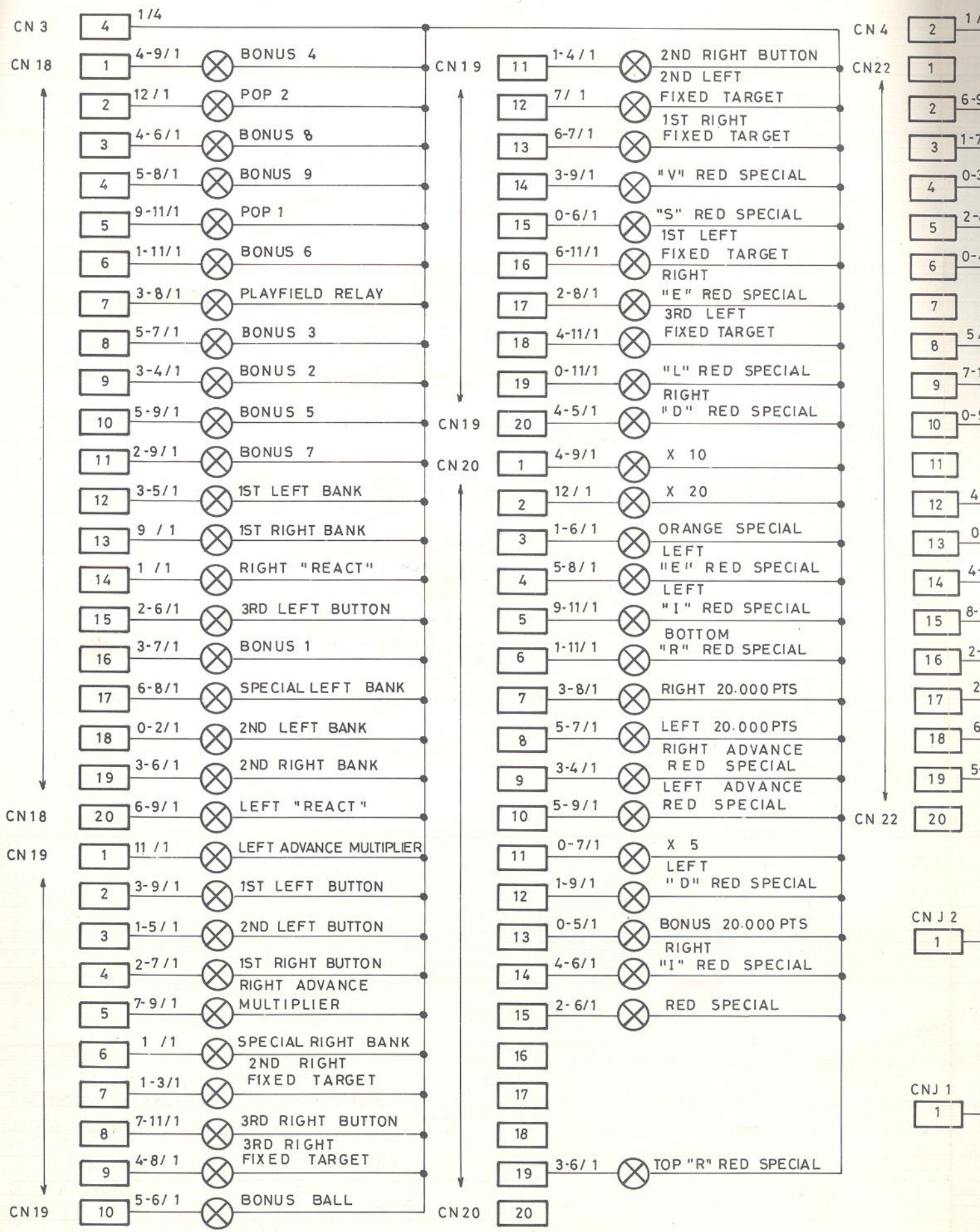

16

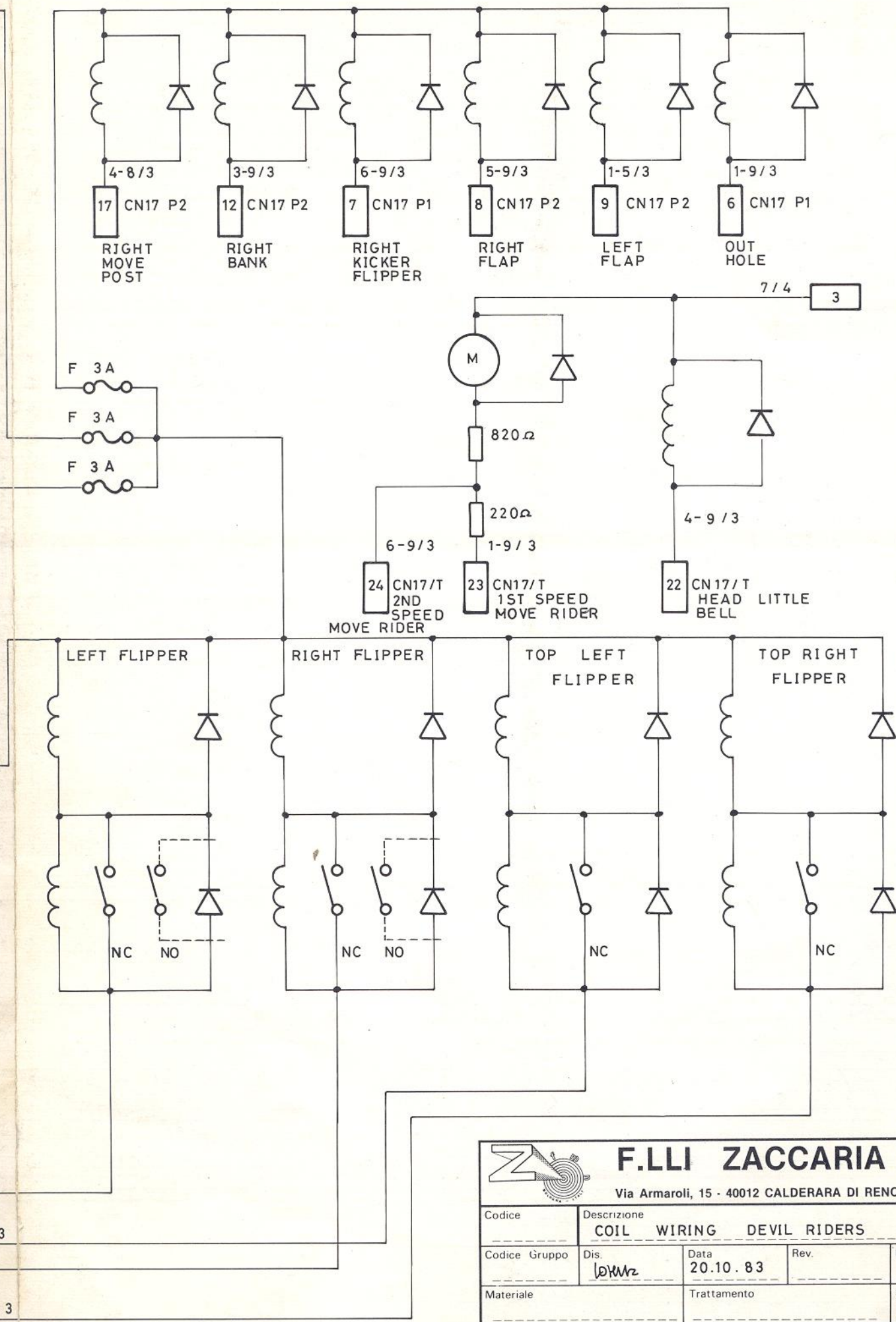

 F.LI ZACCARIA s.n.c. Via Armaroli, 15 - 40012 CALDERARA DI RENO (Bo) ITALY				
Codice	Descrizione COIL WIRING DEVIL RIDERS			
Codice Gruppo	Dis. <i>LDWz</i>	Data 20.10.83	Rev.	Data Rev.
Materiale		Trattamento		Scala
• note :				Foglio

4
3 / 3
4
11 / 3

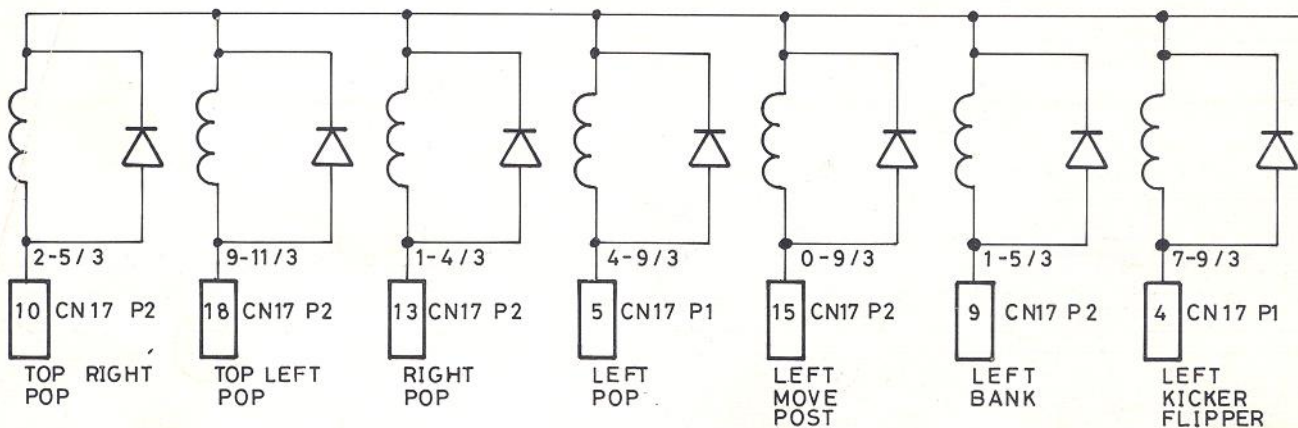
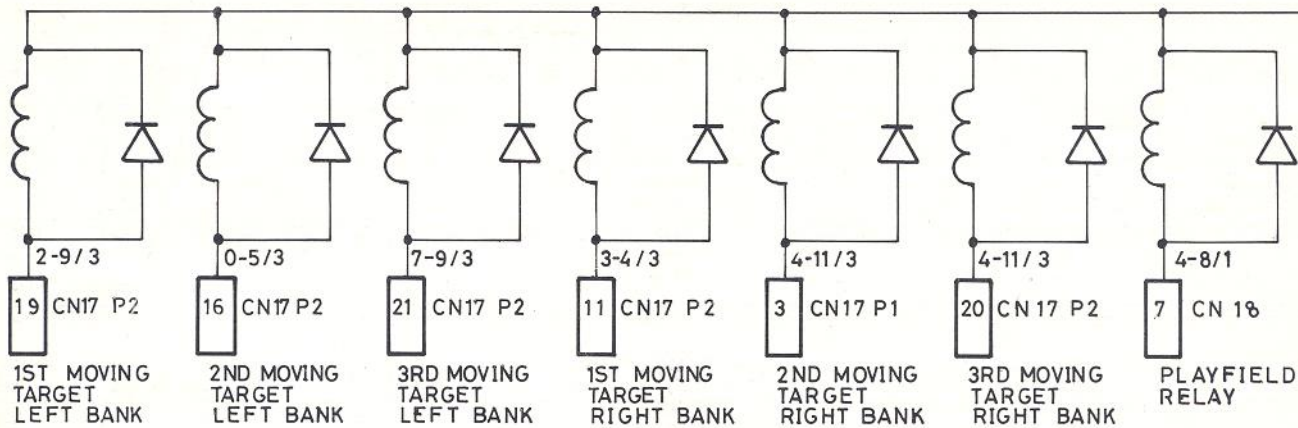

7 / 4

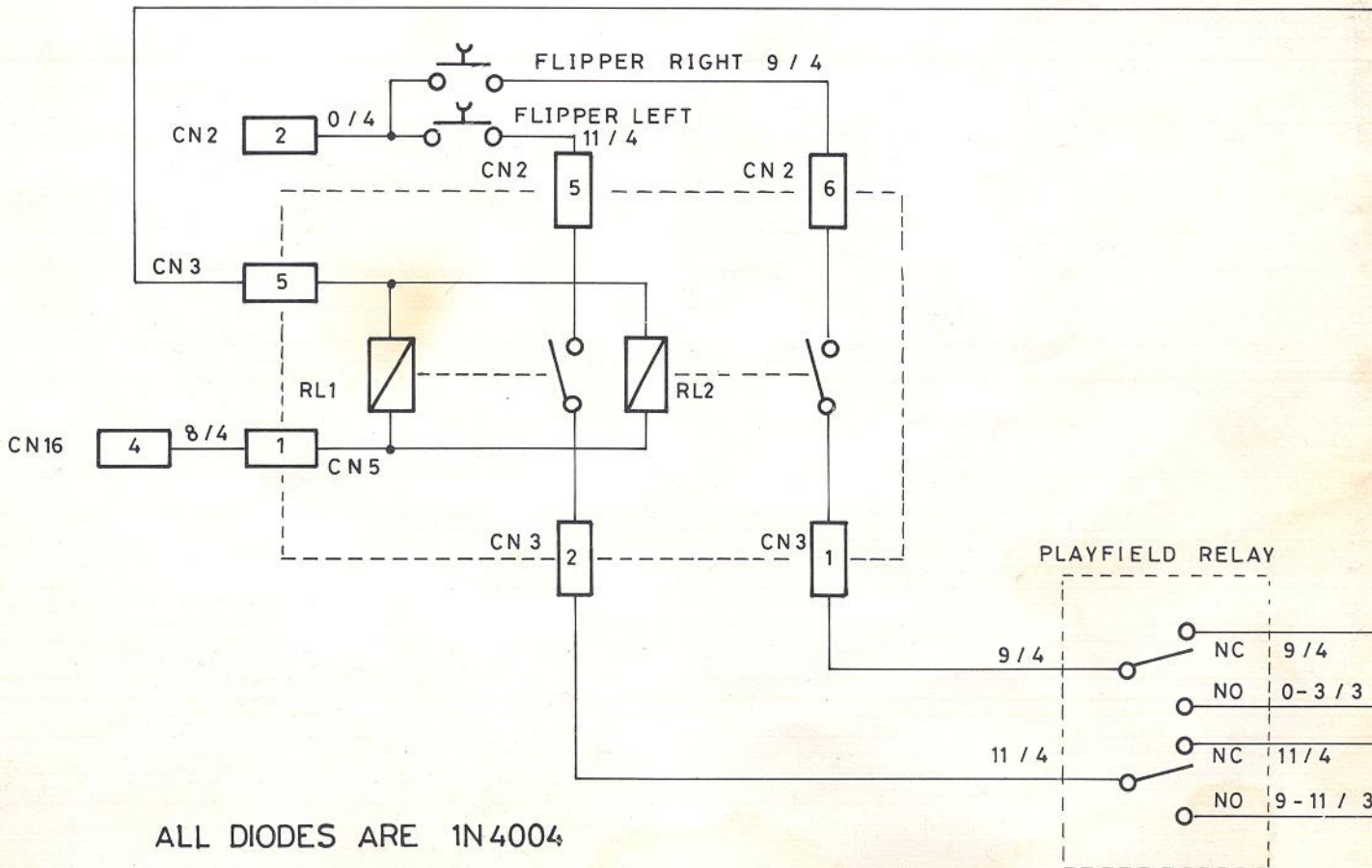

ALL DIODES ARE 1N4004

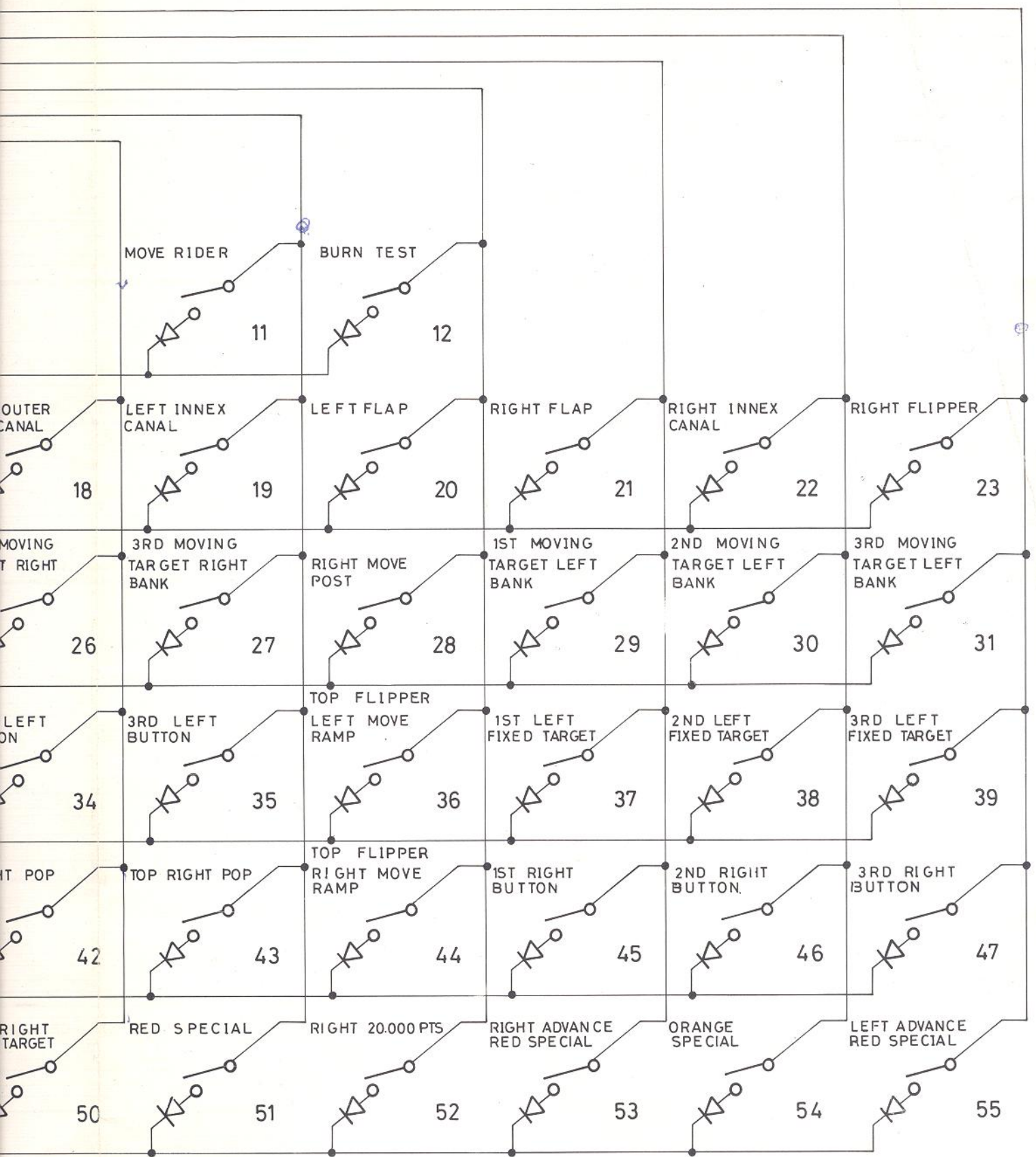

ALL DIODES ARE 1N4148



F.LLI ZACCARIA s.n.c.

Via Armaroli, 15 - 40012 CALDERARA DI RENO (Bo) ITALY

Codice	Descrizione DIAGRAM FOR PLAYFIELD CONTACTS WIRING DEVIL RIDERS			
Codice Gruppo	Dis. lorena	Data 09.11.1983	Rev.	Data Rev.
Materiale	Trattamento		Scala	
note				Foglio

10

2

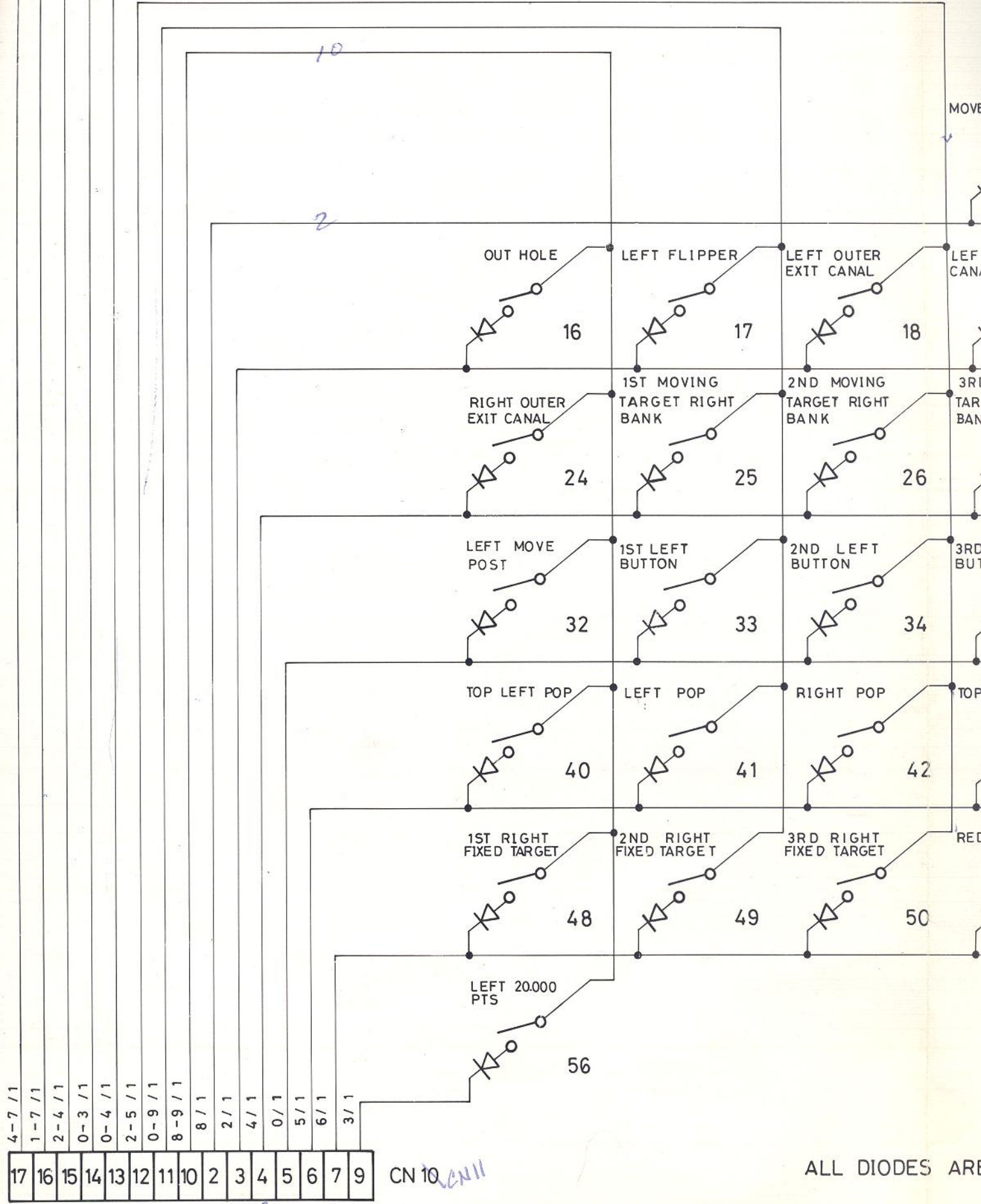

4-7 / 1	1-7 / 1	2-4 / 1	0-3 / 1	0-4 / 1	2-5 / 1	0-9 / 1	8-9 / 1	8 / 1	2 / 1	4 / 1	0 / 1	5 / 1	6 / 1	3 / 1
17	16	15	14	13	12	11	10	2	3	4	5	6	7	9

CN 10 CN 11

ALL DIODES ARE

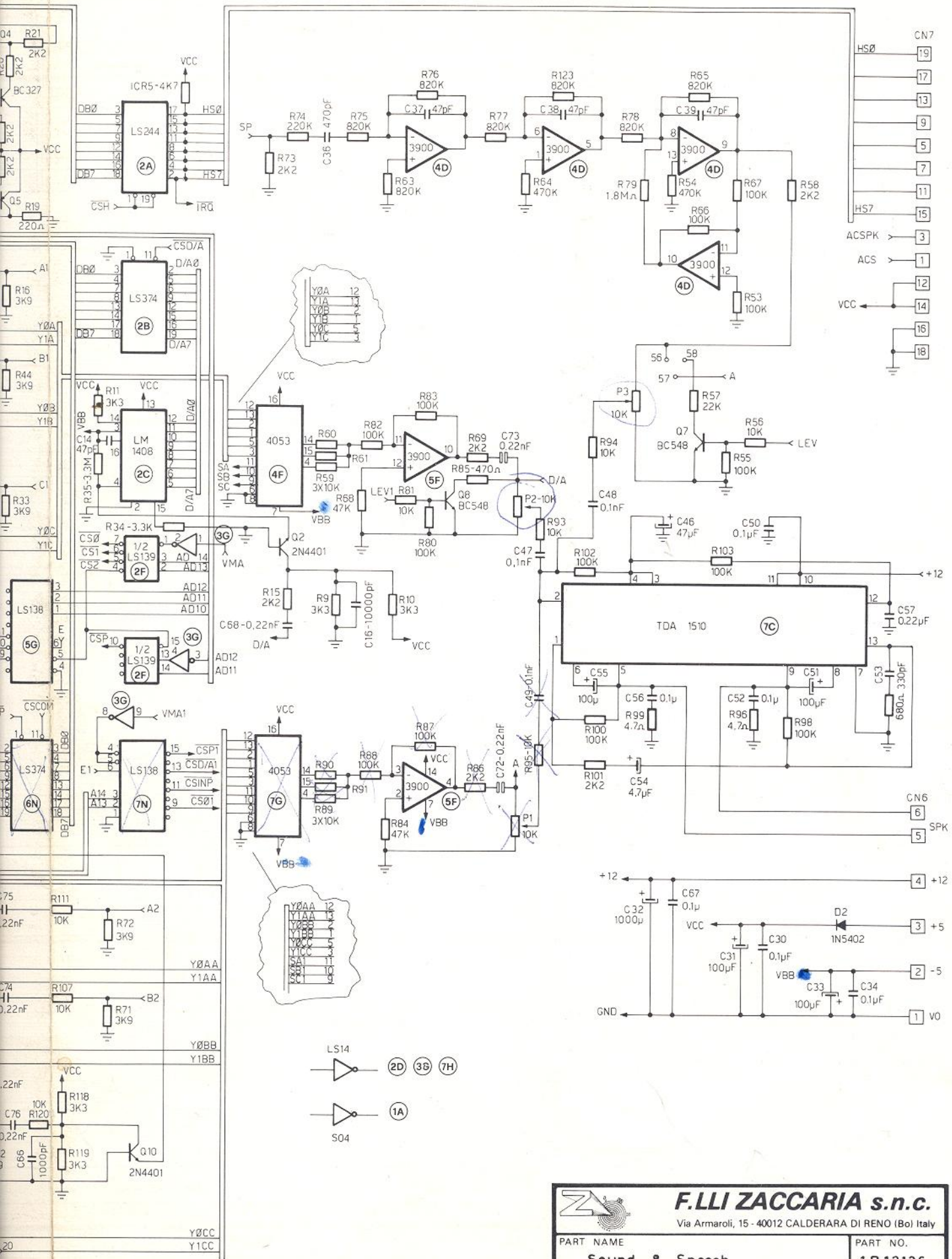

F.LLI ZACCARIA s.n.c.
Via Armaroli, 15 - 40012 CALDERARA DI RENO (Bo) Italy

PART NAME		PART NO.	
Sound & Speech		1B13136	
DWN. <i>Z.G.</i>	DATE <i>28.1.88</i>	REV. <i>P</i>	DATE REV. <i>27/10</i>
NOTES: UNLESS OTHERWISE SPECIFIED		SHEET	
1) ALL RESISTORS VALUES IN		-----	
2) ALL CAPACITORS VALUES IN		-----	

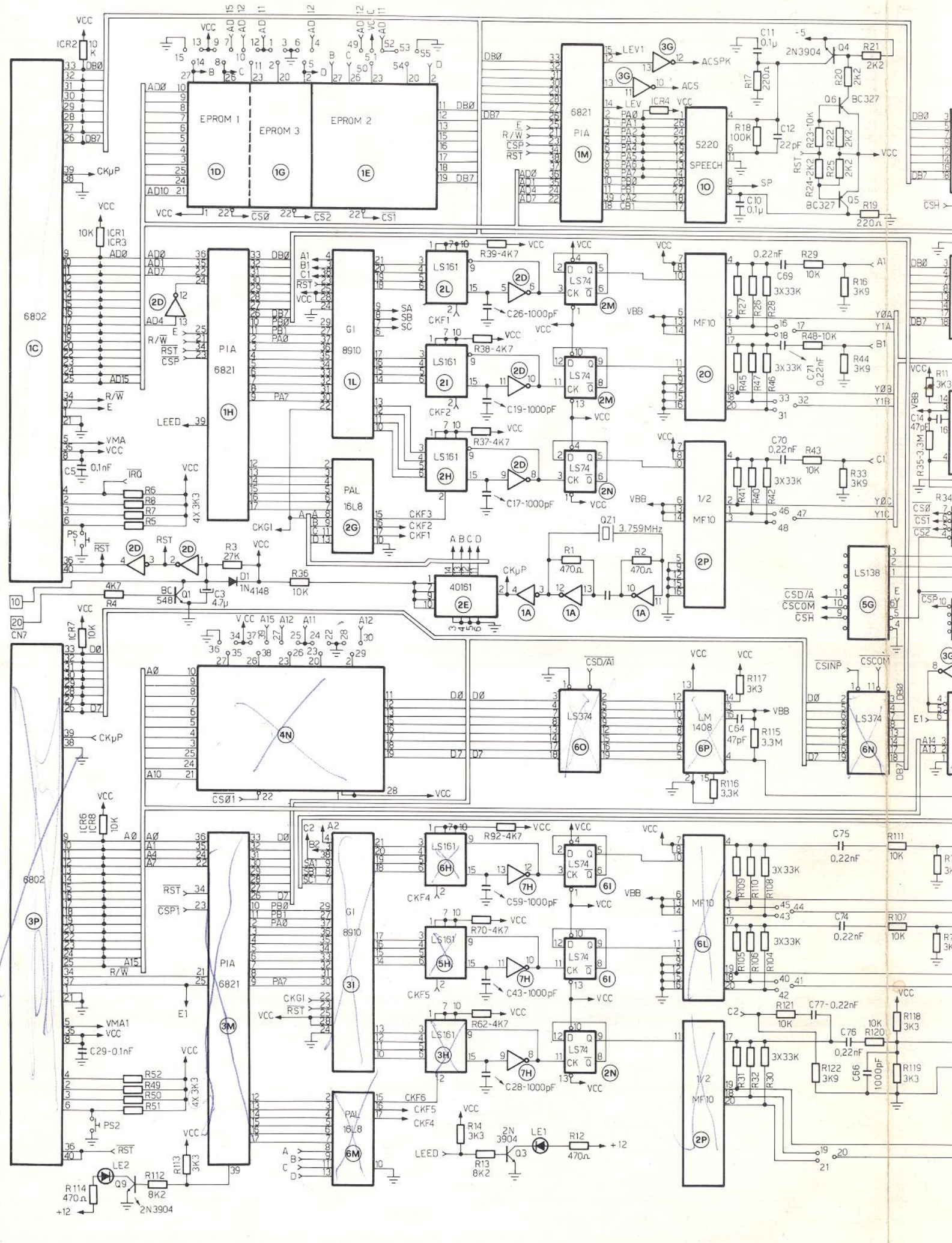

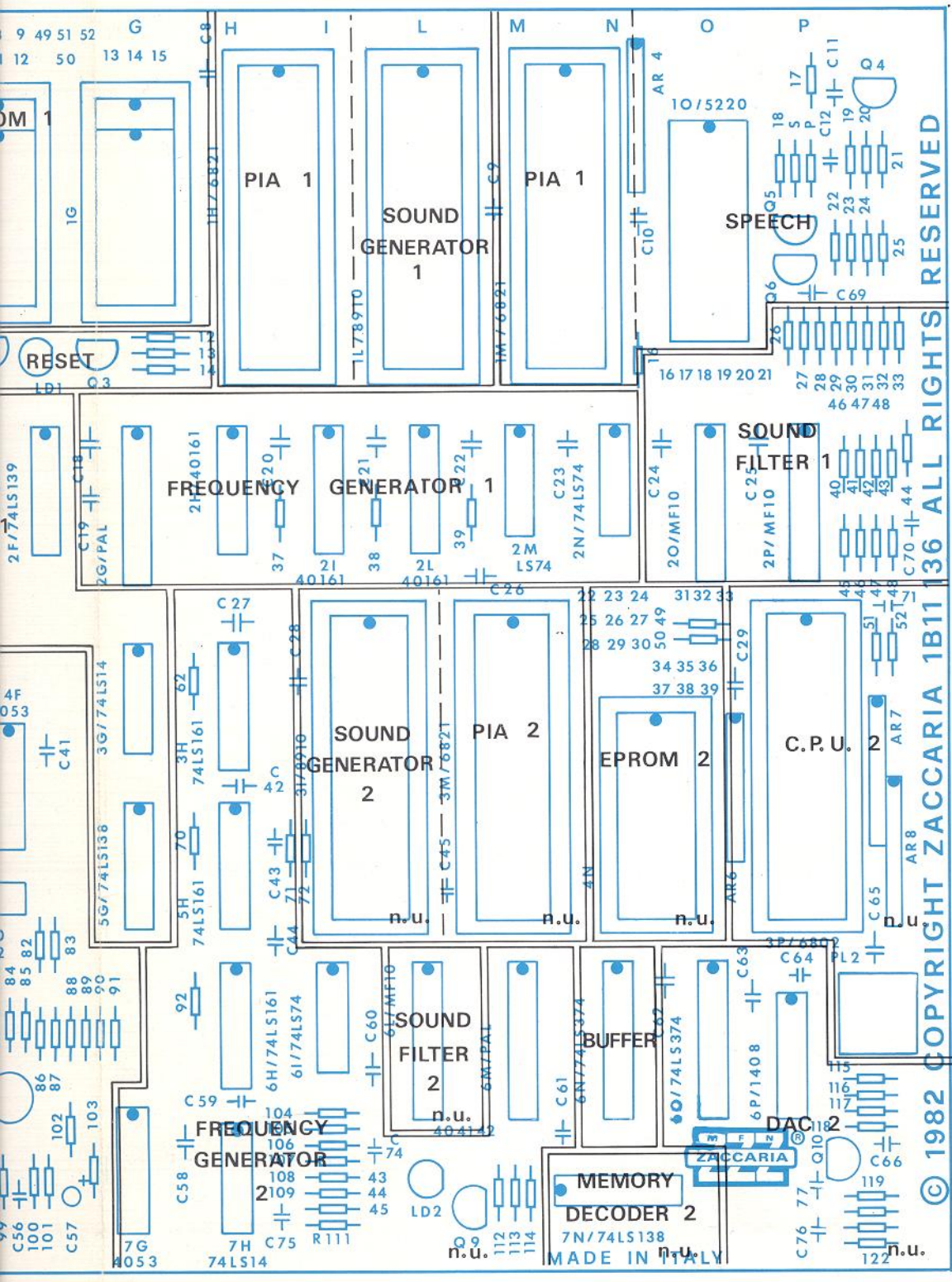

© 1982 COPYRIGHT ZACCARIA 1B11 136 ALL RIGHTS RESERVED

MEMORY DECODER 2
7N/74LS138
MADE IN ITALY

ZACCARIA

SOUND & SPEECH board

P.C. 1B11136

13

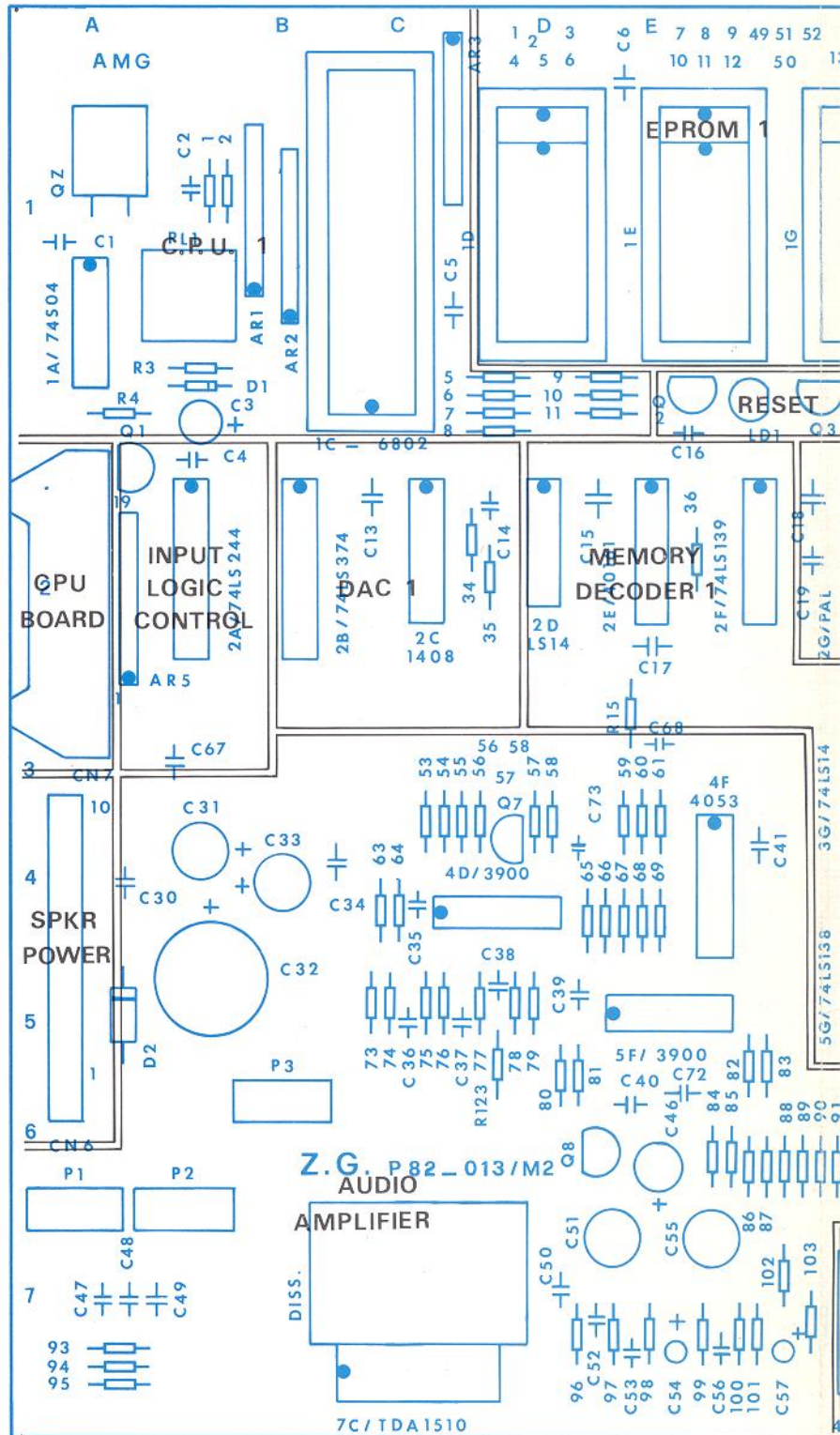

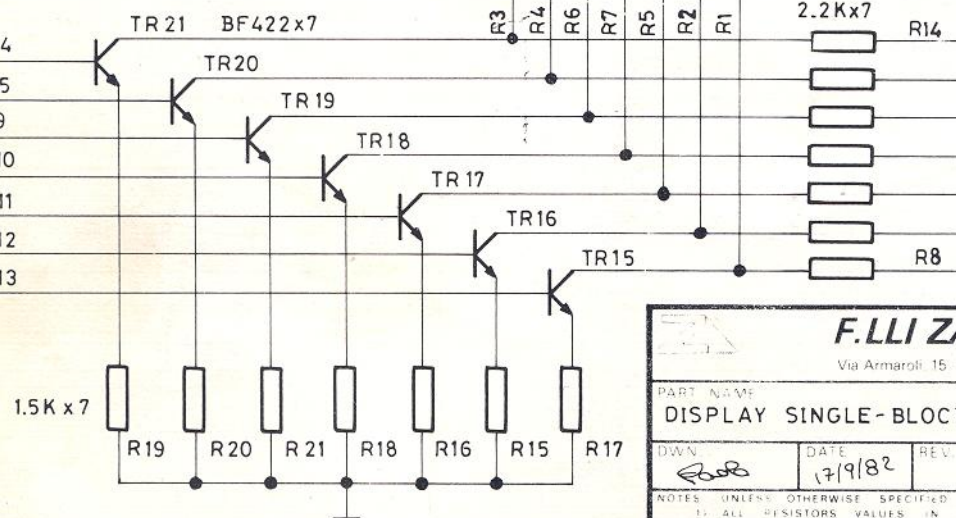
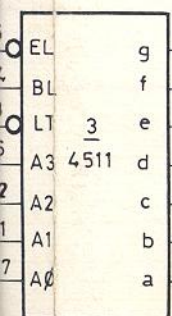
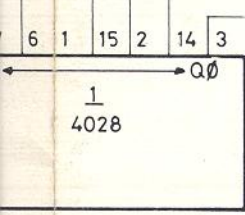
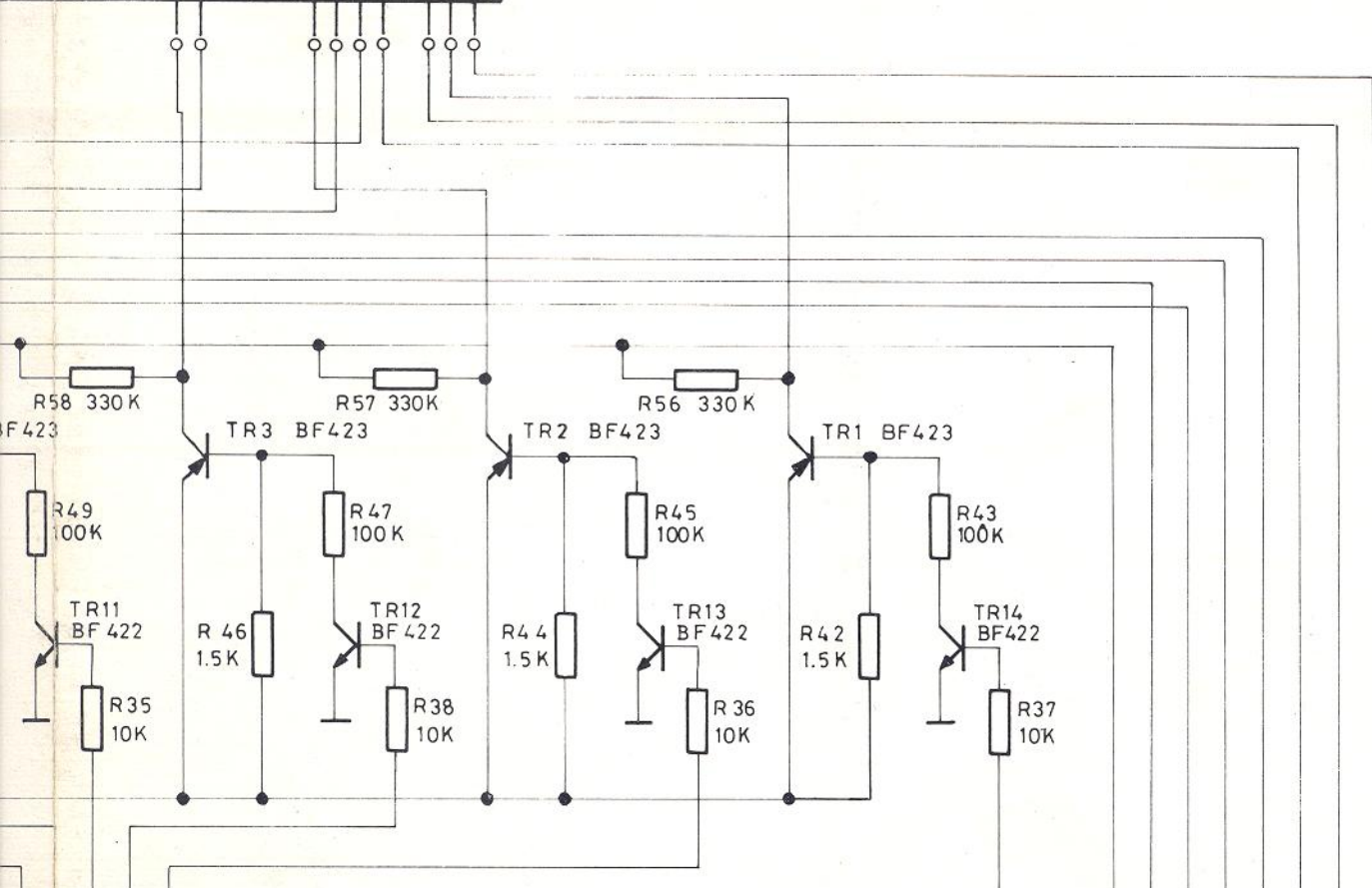
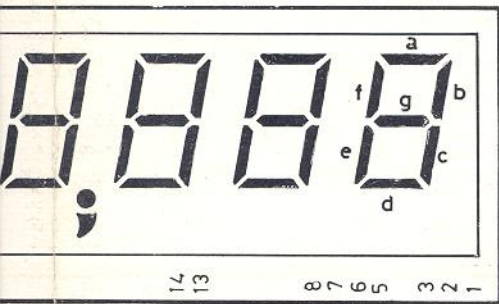

F.LLI ZACCARIA s.n.c.
Via Armaroli 15 40012 CALDERARA DI RENO (Bo) Italy

PART NAME		PART NO.	
DISPLAY SINGLE-BLOCK DRIVER (transistor)		1B13123	
DWN	DATE	REV.	DATE REV.
	17/9/82		
SHEET			

NOTES: UNLESS OTHERWISE SPECIFIED
1. ALL RESISTORS VALUES IN
2. ALL CAPACITORS VALUES IN

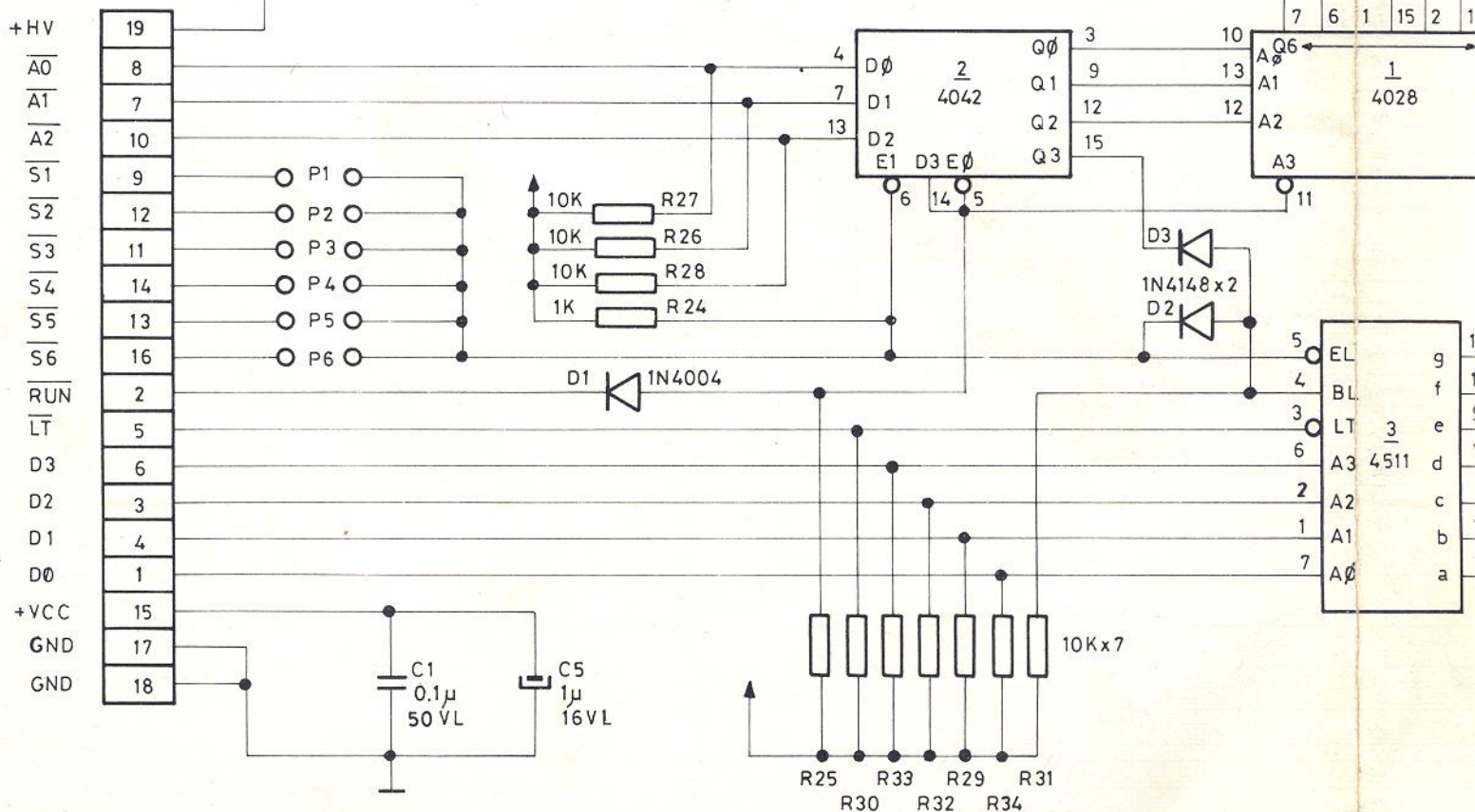
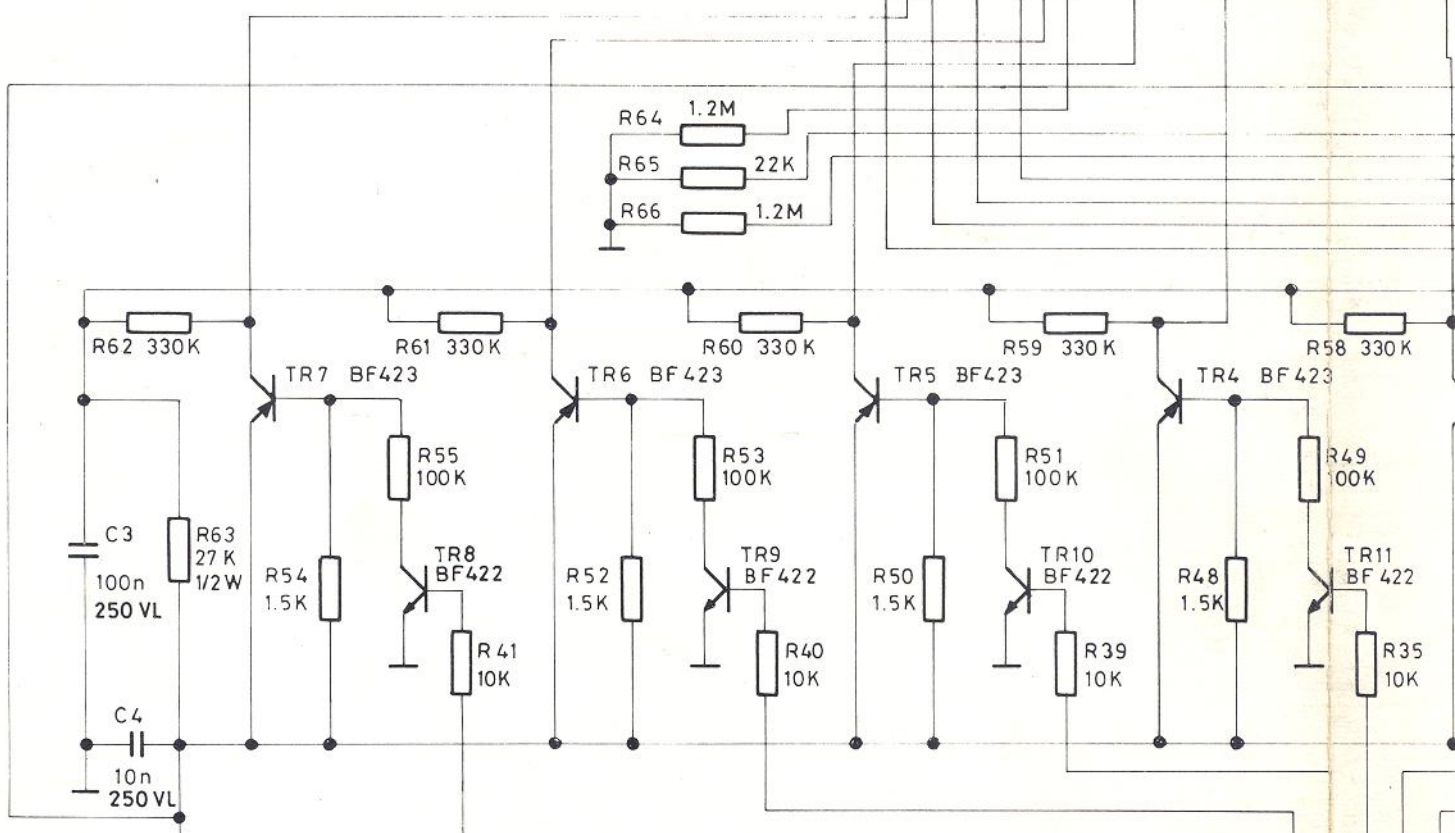
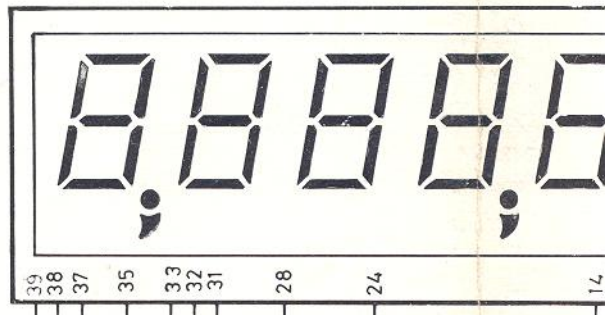

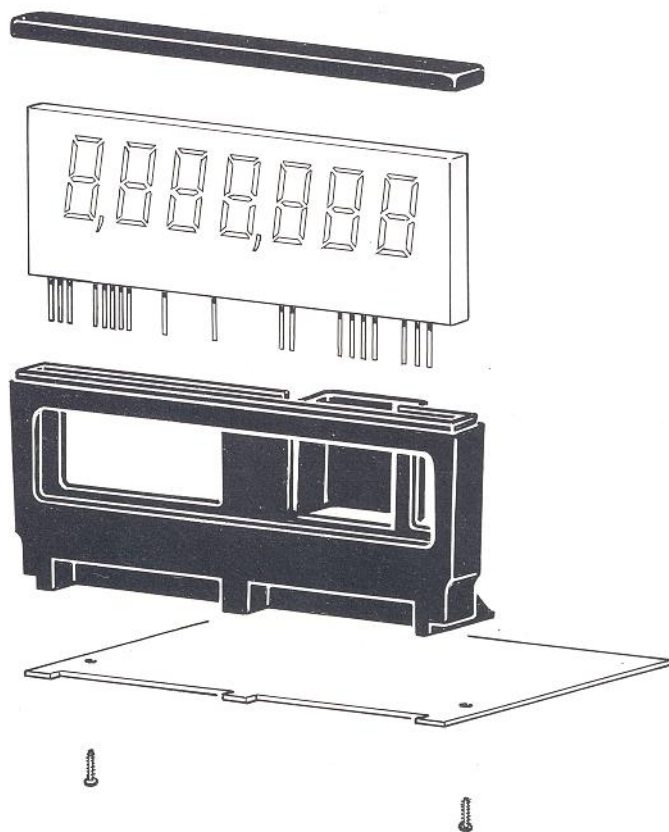

DRIVER DISPLAY board

P.C. 1B1123

11
44Ω = E-C of T6

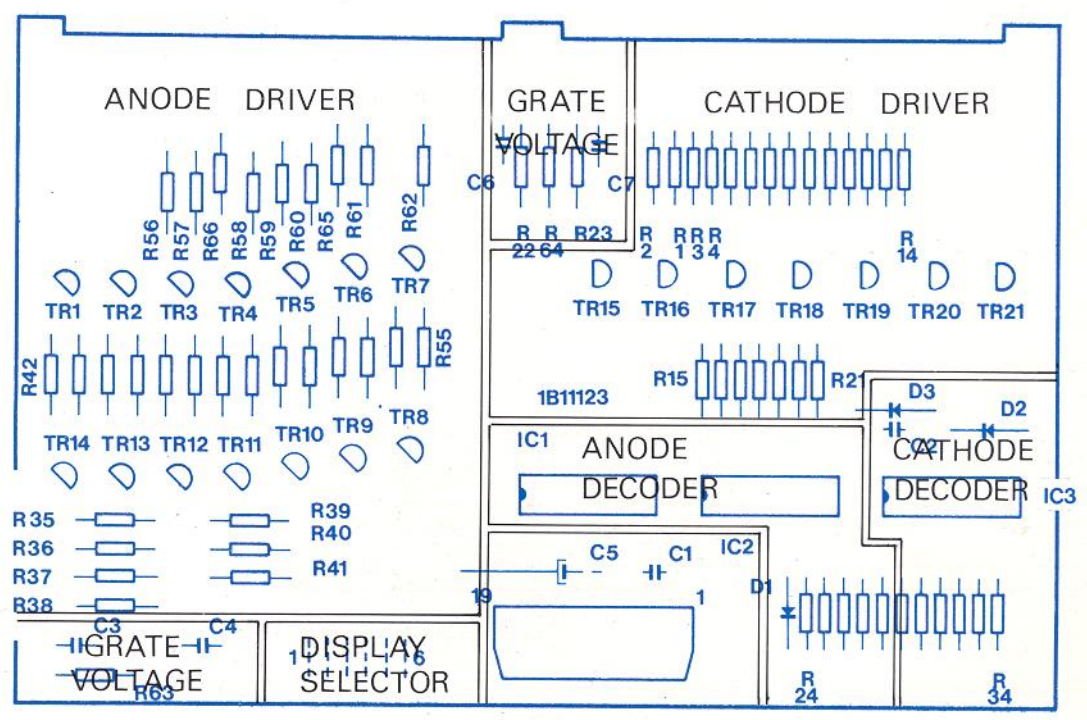

C.P.U. BOARD

COMPARATOR (GOOD READINGS in BLUE) and encircled

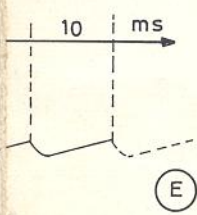
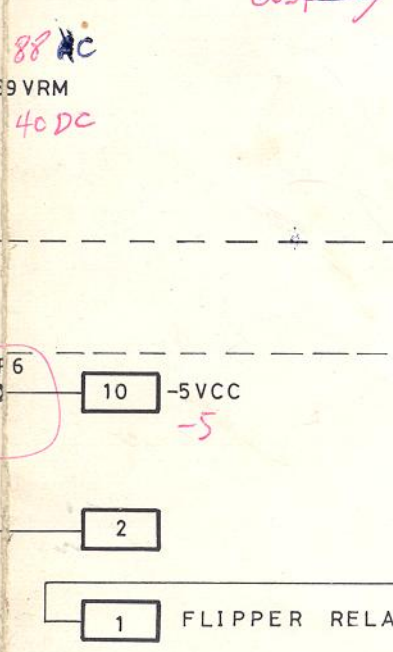
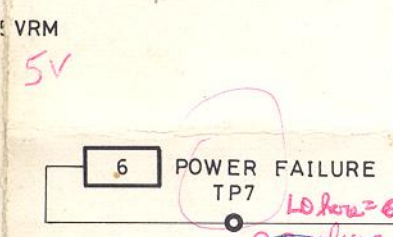
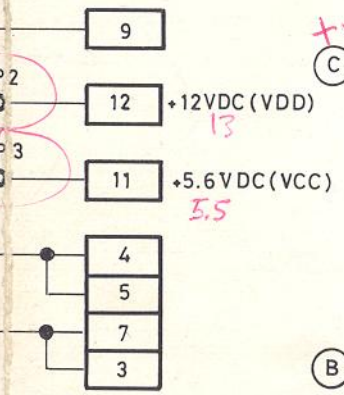
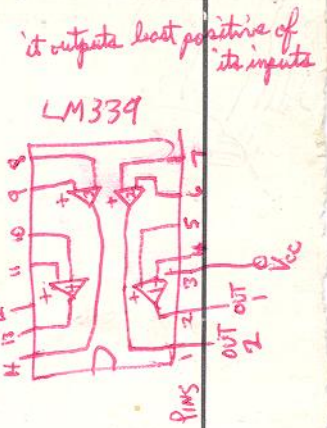
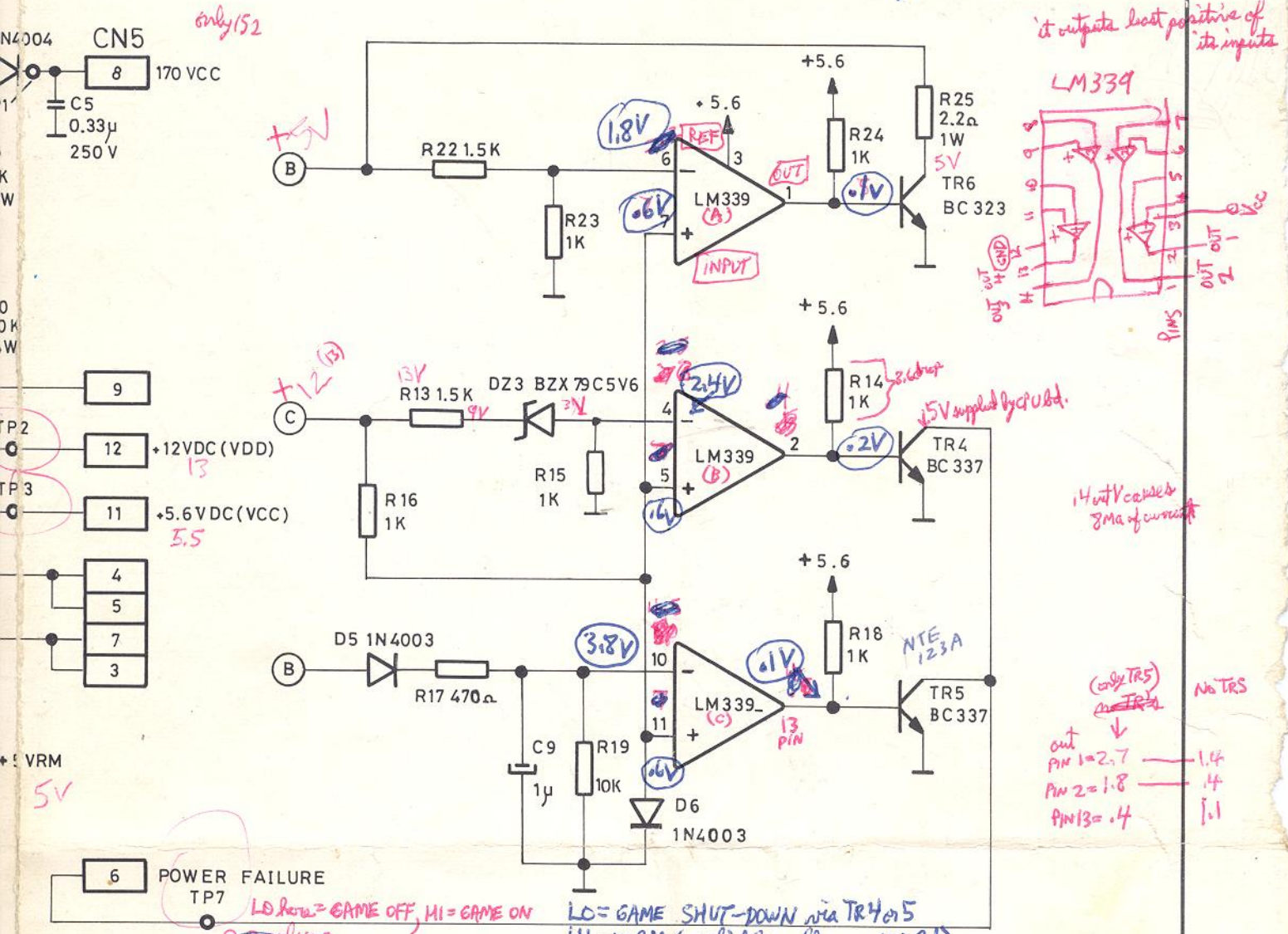

* WITH HEAT SINK

LD = GAME OFF, HI = GAME ON

LO = GAME SHUT-DOWN via TR4 or 5
HI = NORM (supplied by pull-up on CPU Bd)

POSSIBLE IDEA of DESIGNER

IF 12V DIES, THE GAME SHOULD CUT OFF. TP7 (HELD HI ON THE CPU BD) CAN BE MADE LD BY THE "B" OR "C" COMPARATOR. WITH NO © VOLTAGE THERE WILL BE NO .4V output, the inadequate bias which leaves TR4 + TR5 turned off. But, lacking the .7V reference, the comparators will then output their only remaining input (+2.5V of LM339, pin 4 --- and/or 4.5V of pin 10) This will amply turned on one or both of TR4, TR5 and drag TP7 to ground (NO GO status).

[This is only a guess, but the note at TP7 is quite true: LD = GAME DEAD HI = GAME WORKS]

F.LI ZACCARIA s.n.c.
Via, Armaroli, 15 - 40012 CALDERARA DI RENO (Bo) Italy

PART NAME Electrical diagram for POWER BOARD		PART NO. 1B1367/0	
DWN. <i>[Signature]</i>	DATE 26/7/82	REV.	DATE REV.
NOTES: UNLESS OTHERWISE SPECIFIED		SHEET	
1) ALL RESISTORS VALUES IN			
2) ALL CAPACITORS VALUES IN			

170V?
Do wave + Voltage
55M etc

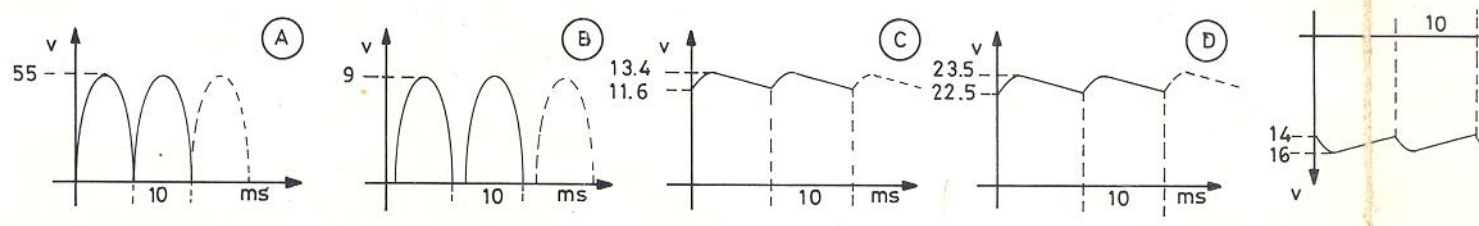
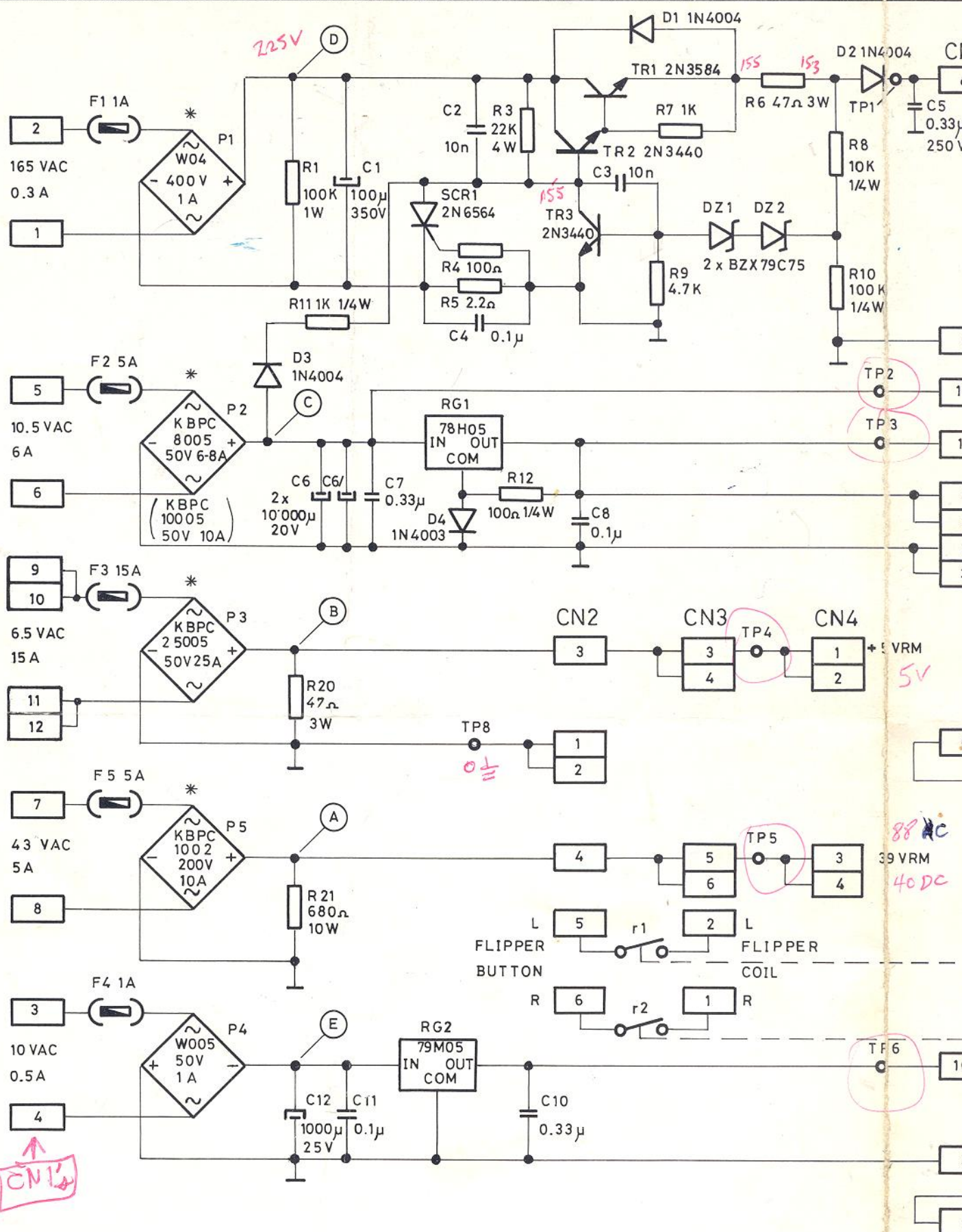

1 CPU INTERFACE SOUND

TP1

CN5

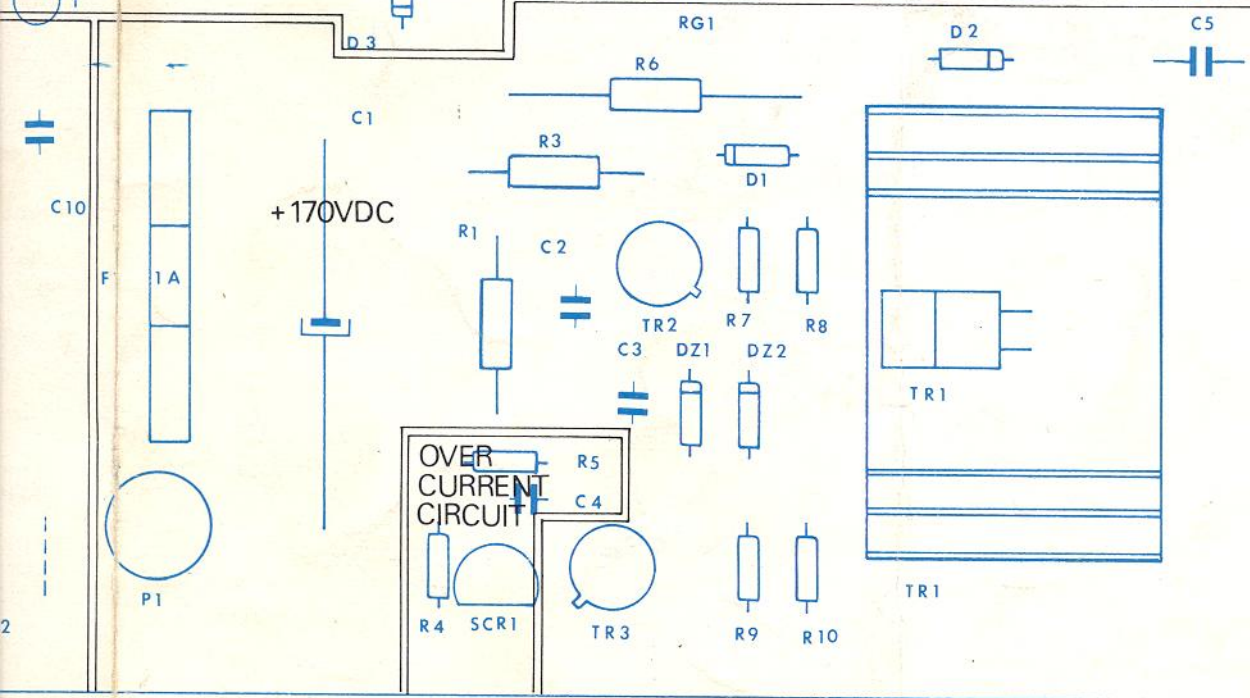
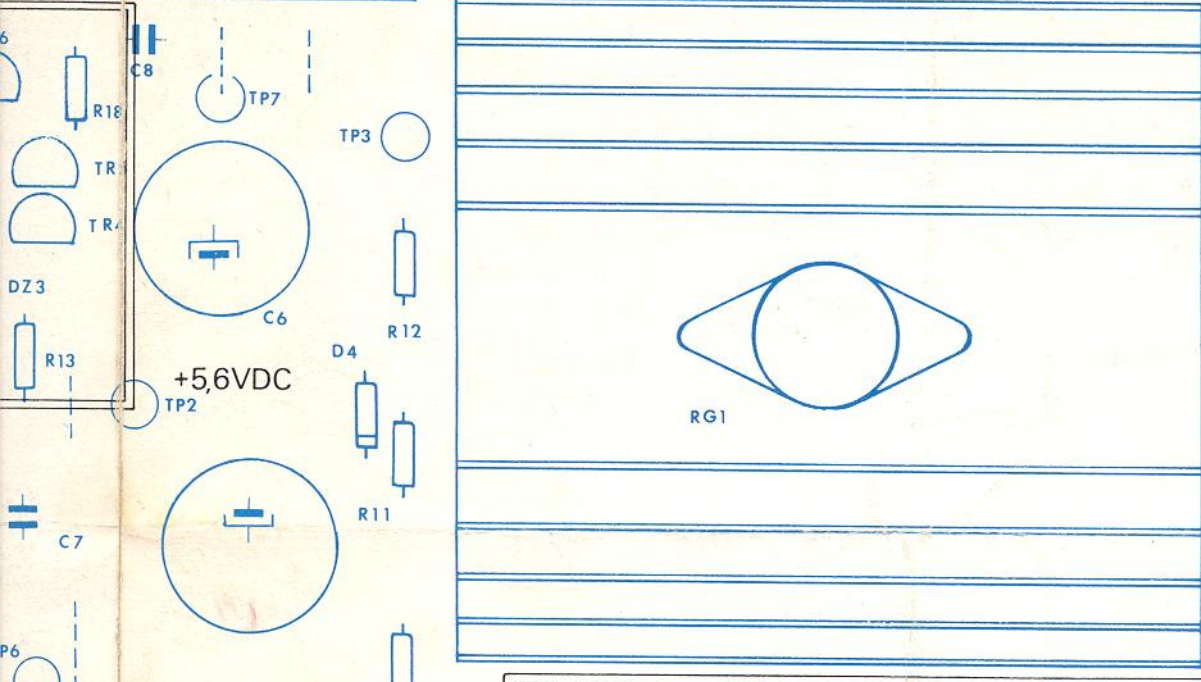

OVER CURRENT CIRCUIT

POWER board

P.C. 1B1167/0

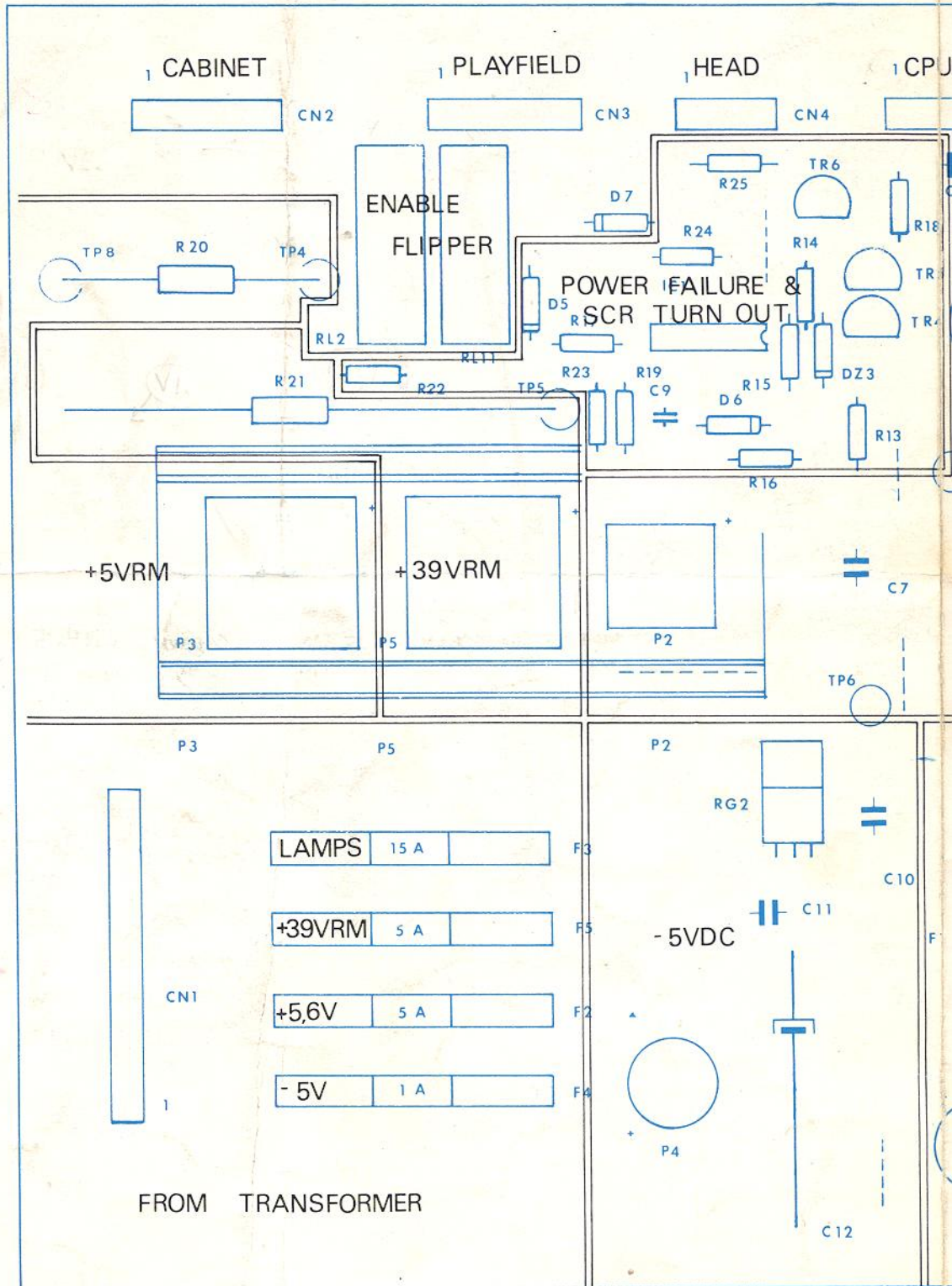

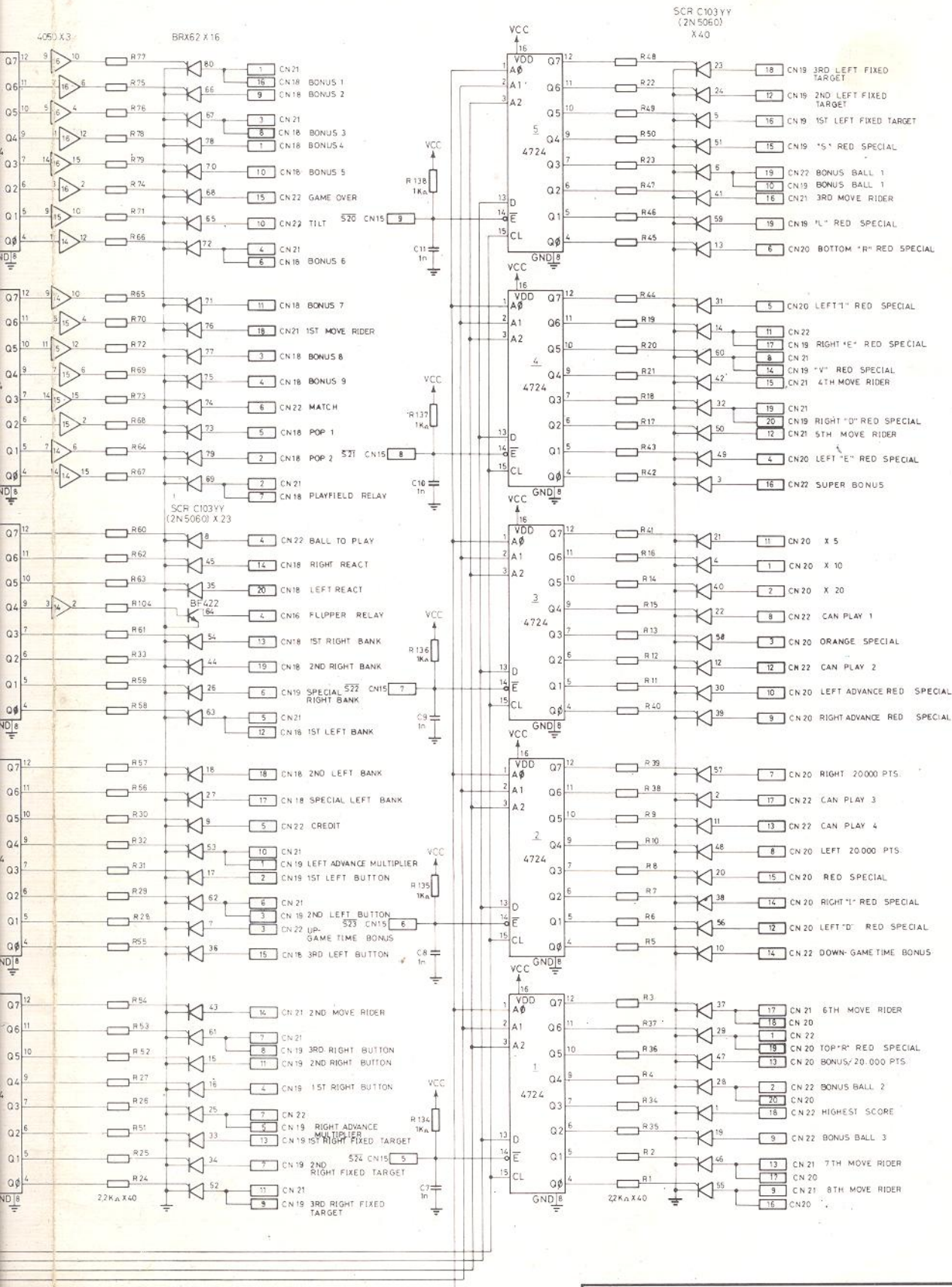

F.LLI ZACCARIA s.n.c.

Via Armadori, 15 - 40012 CALDERARA DI RENO (Bo) ITALY

Codice 1B 1366		Descrizione INTERFACE Board "DEVIL RIDERS"		
Codice Gruppo	Dis.	Data 28.11.83	Rev.	Data Rev
Materiale		Trattamento		Scala
note				Foglio

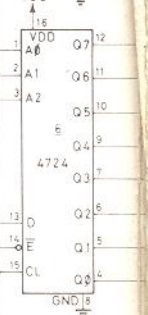
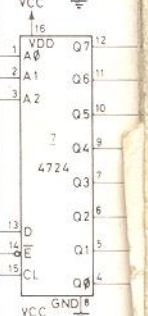
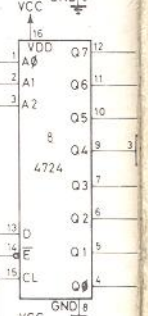
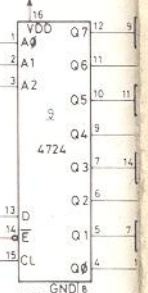
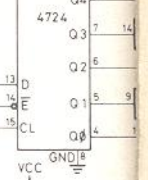
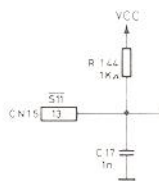
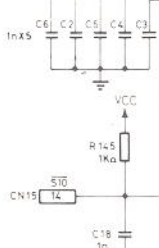
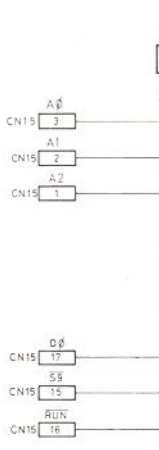
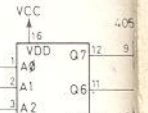
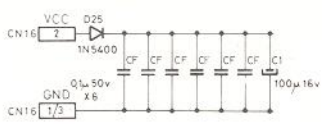
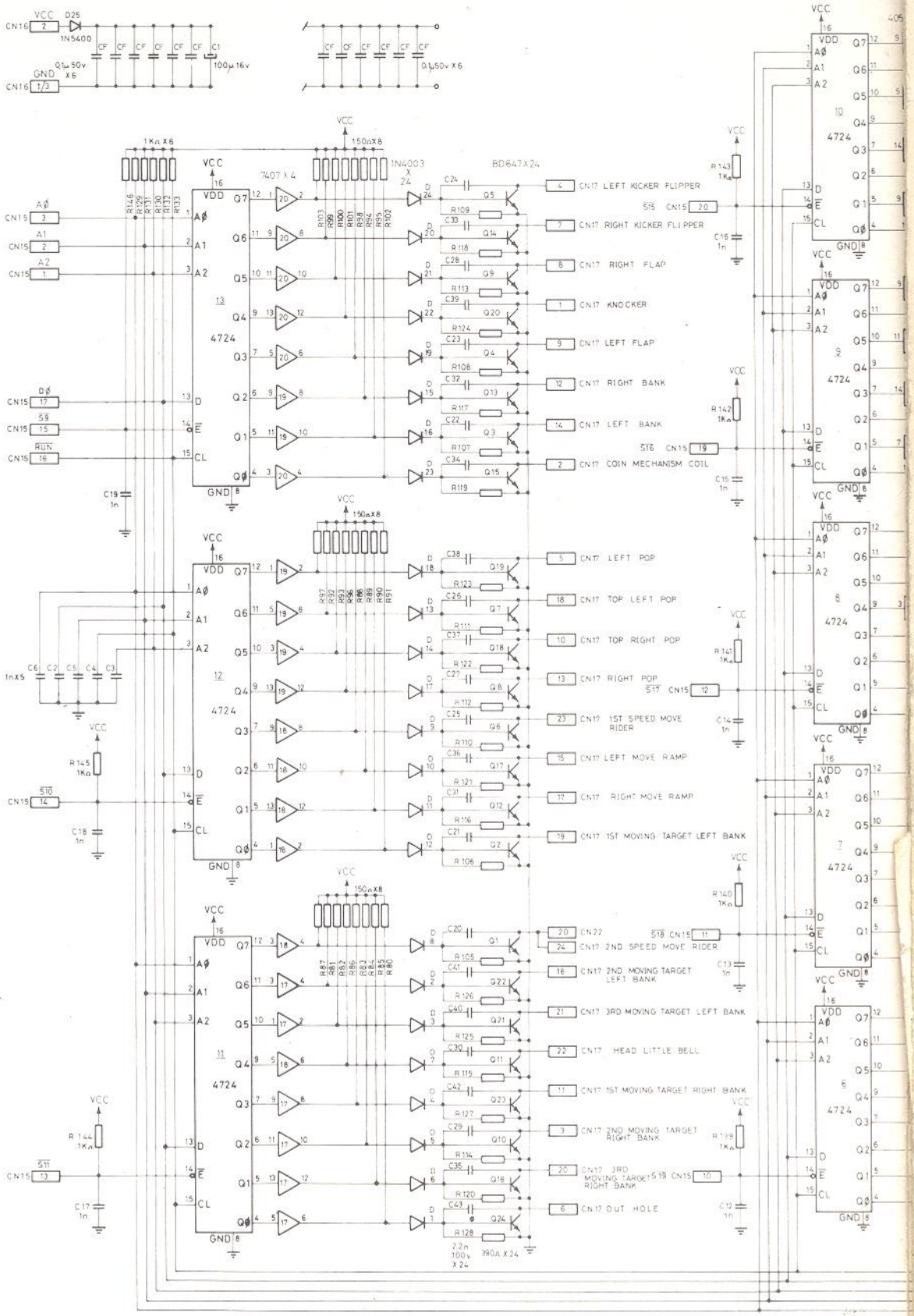

C.P.U. BOARD

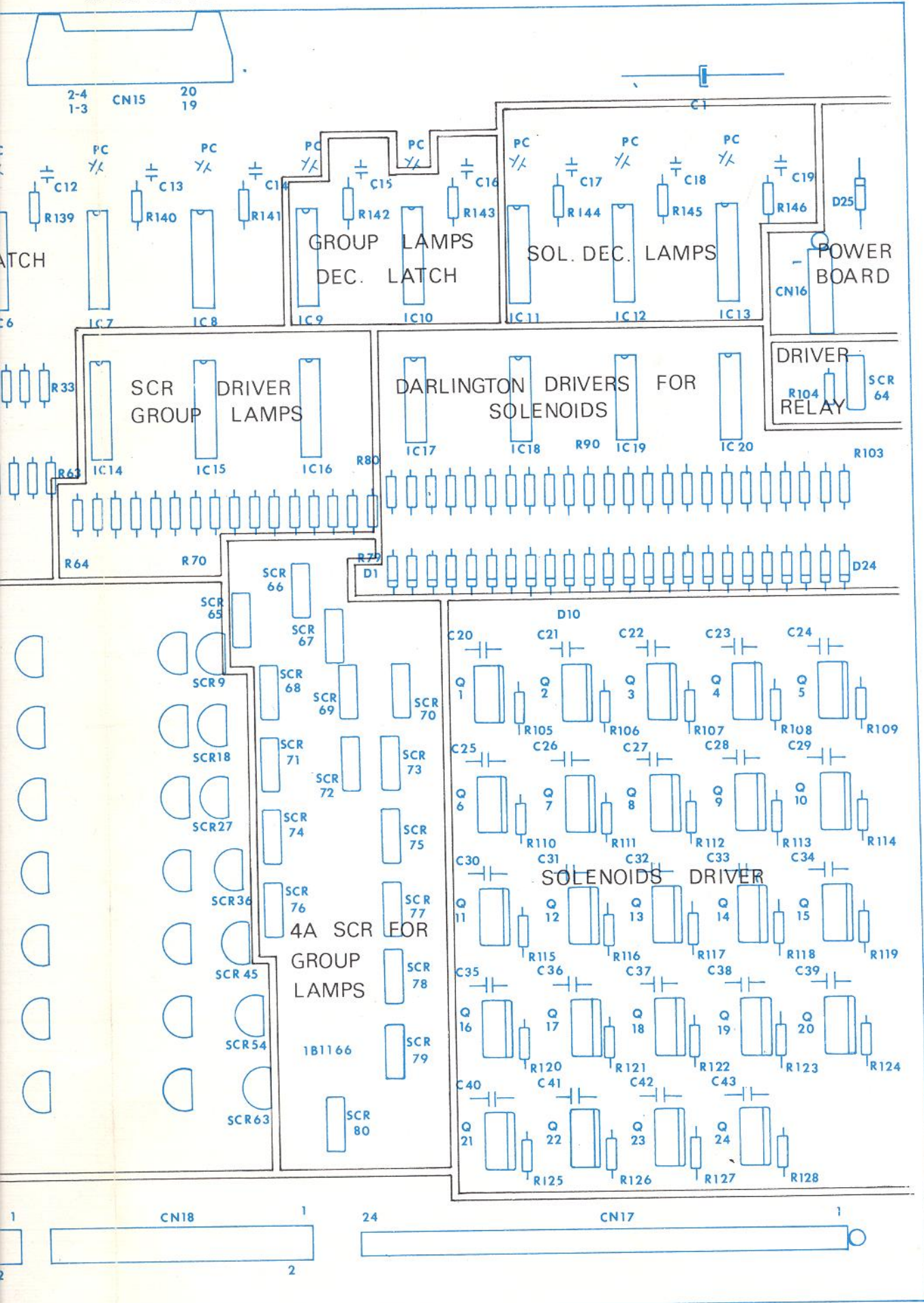

PLAYFIELD

CABINET

INTERFACE board

P.C. 1B1166

C.F.

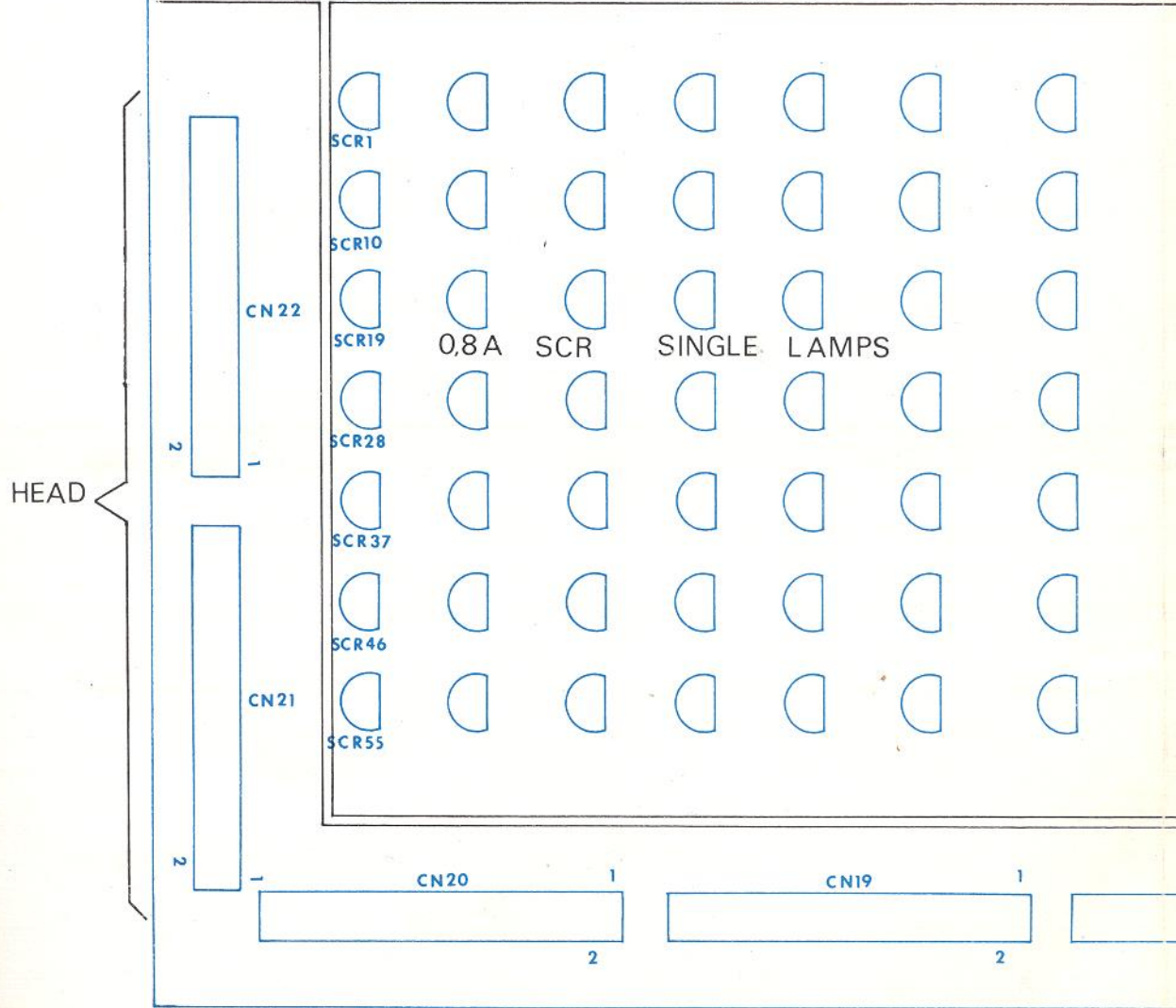
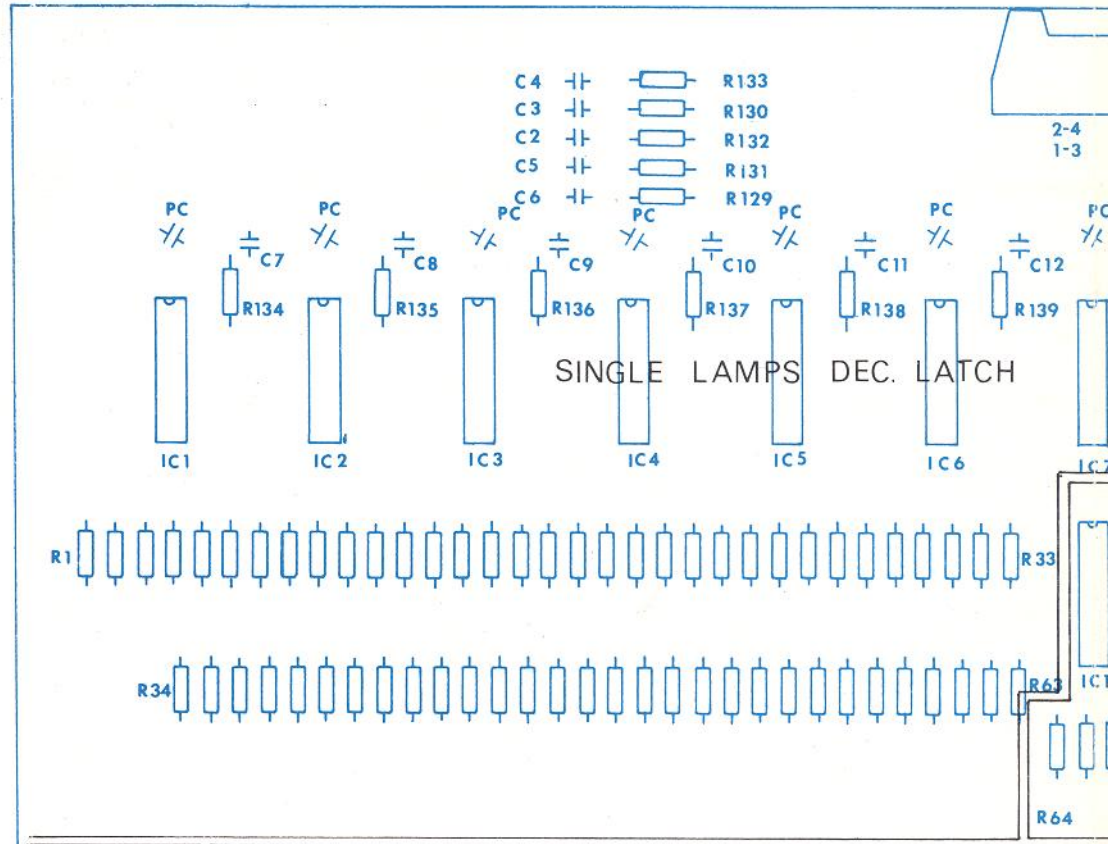

6

108

CN

Added
nu 2647412X

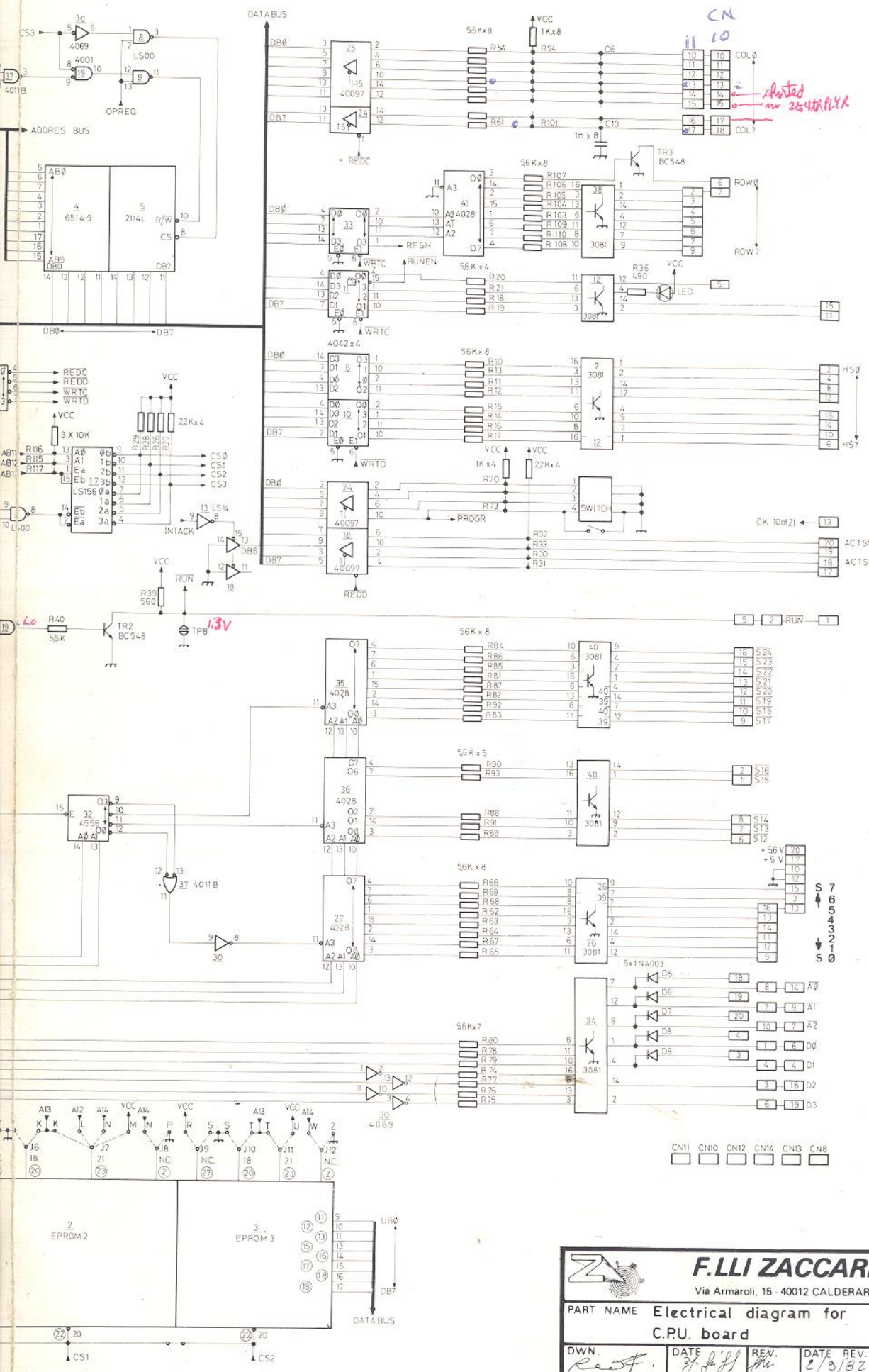

F.LI ZACCARIA s.n.c.
Via Armadori, 15 - 40012 CALDERARA DI RENO (Bo) Italy

PART NAME	Electrical diagram for	PART NO.
	C.P.U. board	1B 13 65/1
DWN.	DATE	REV.
Rest.	27.10.82	2/3/82
NOTES UNLESS OTHERWISE SPECIFIED		SHEET
1) ALL RESISTORS VALUES IN		
2) ALL CAPACITORS VALUES IN		

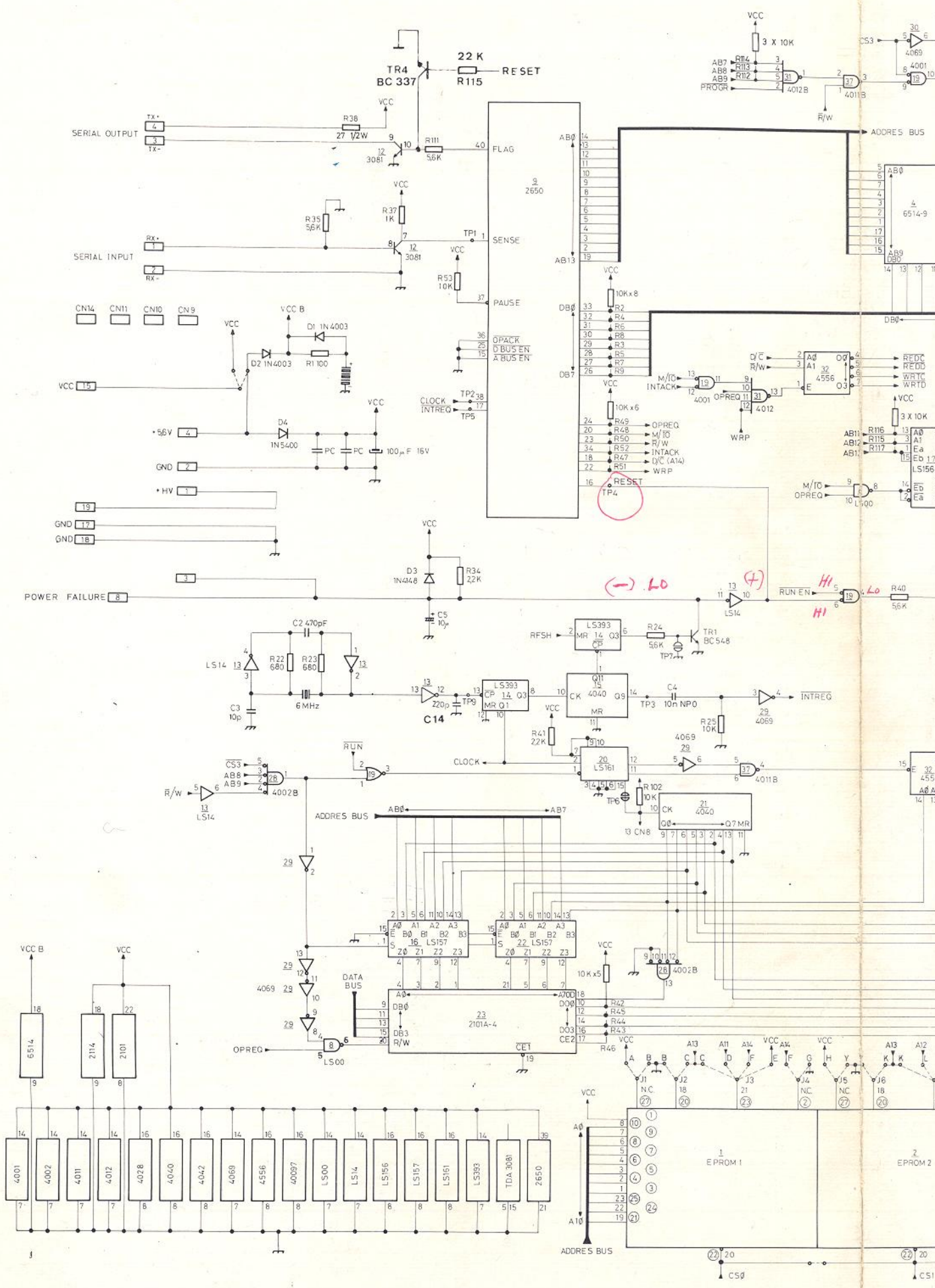

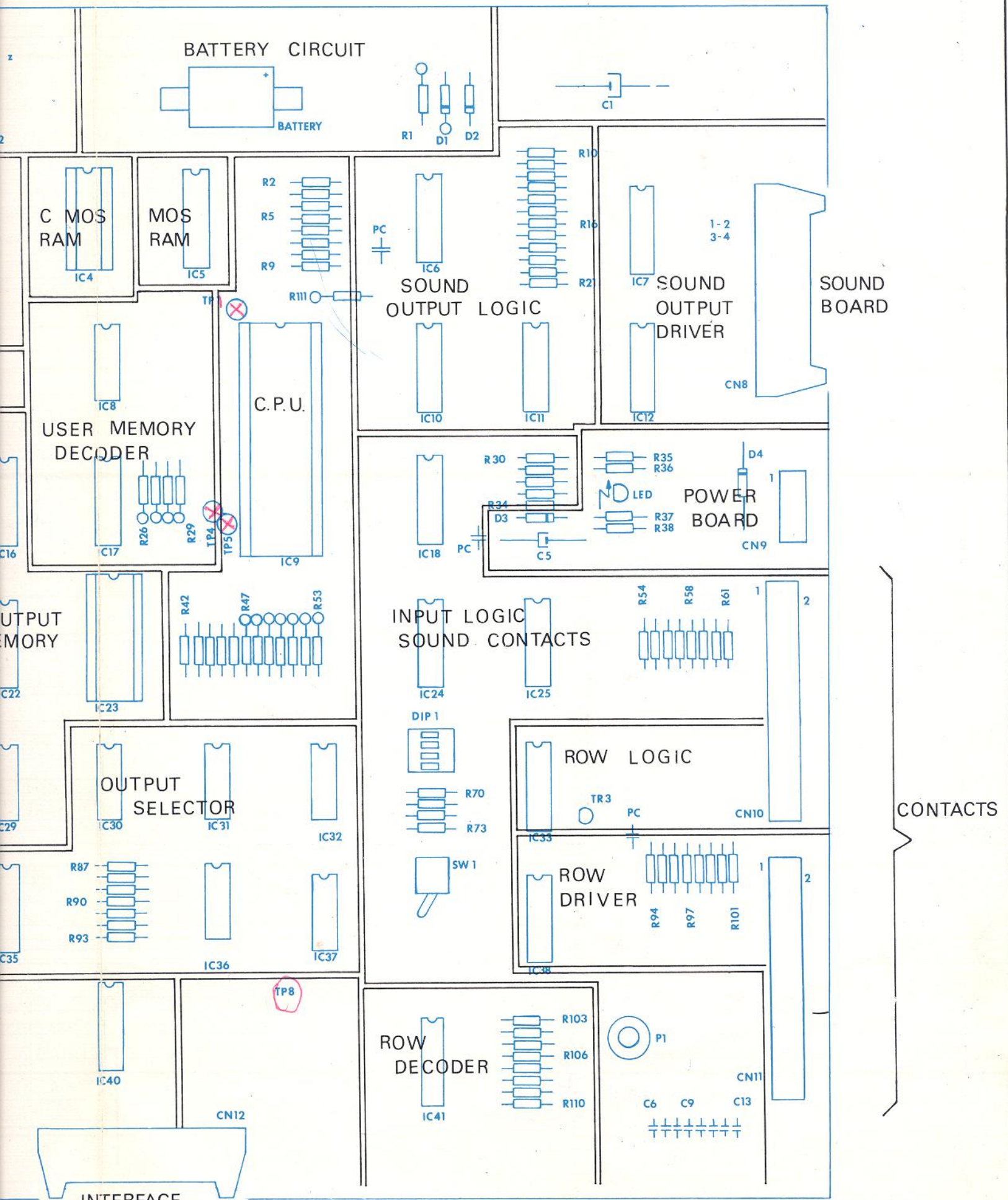

CONTACTS

INTERFACE BOARD

C.P.U. board

P.C.1 B 1165/1

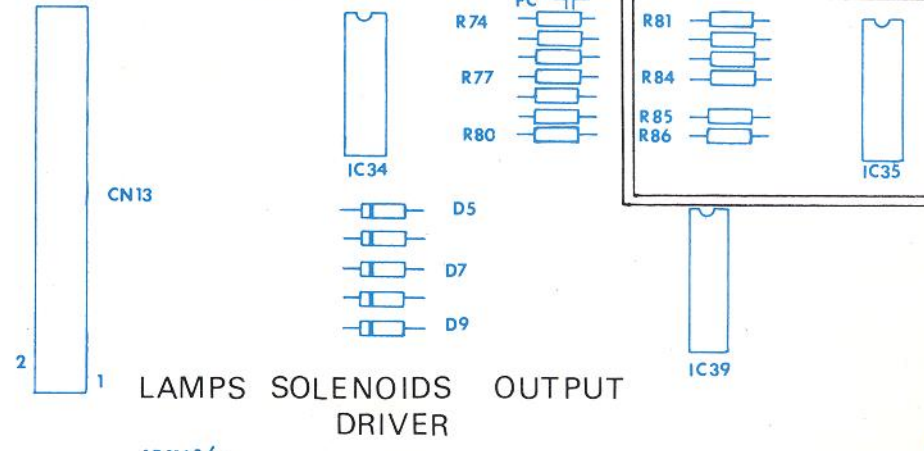
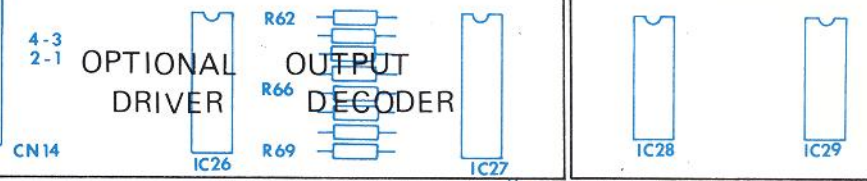
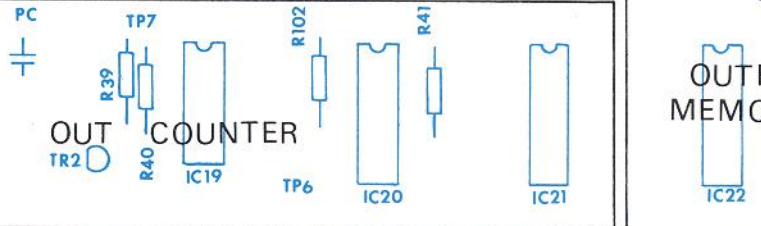
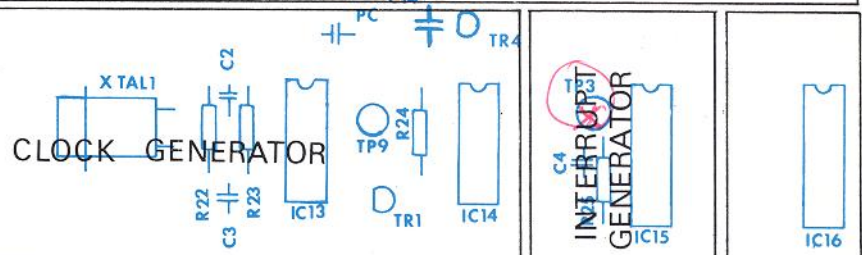
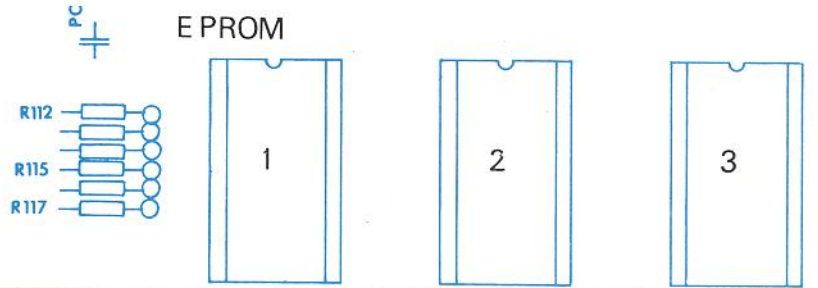
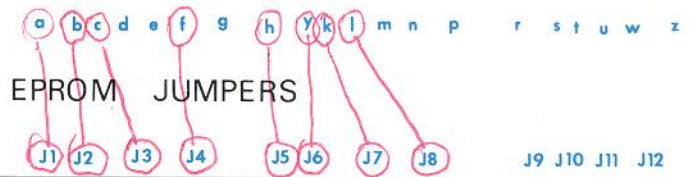

1B1165/1

TPs

1

2 3 4 5

7 6

8

DISPLAY BOARD

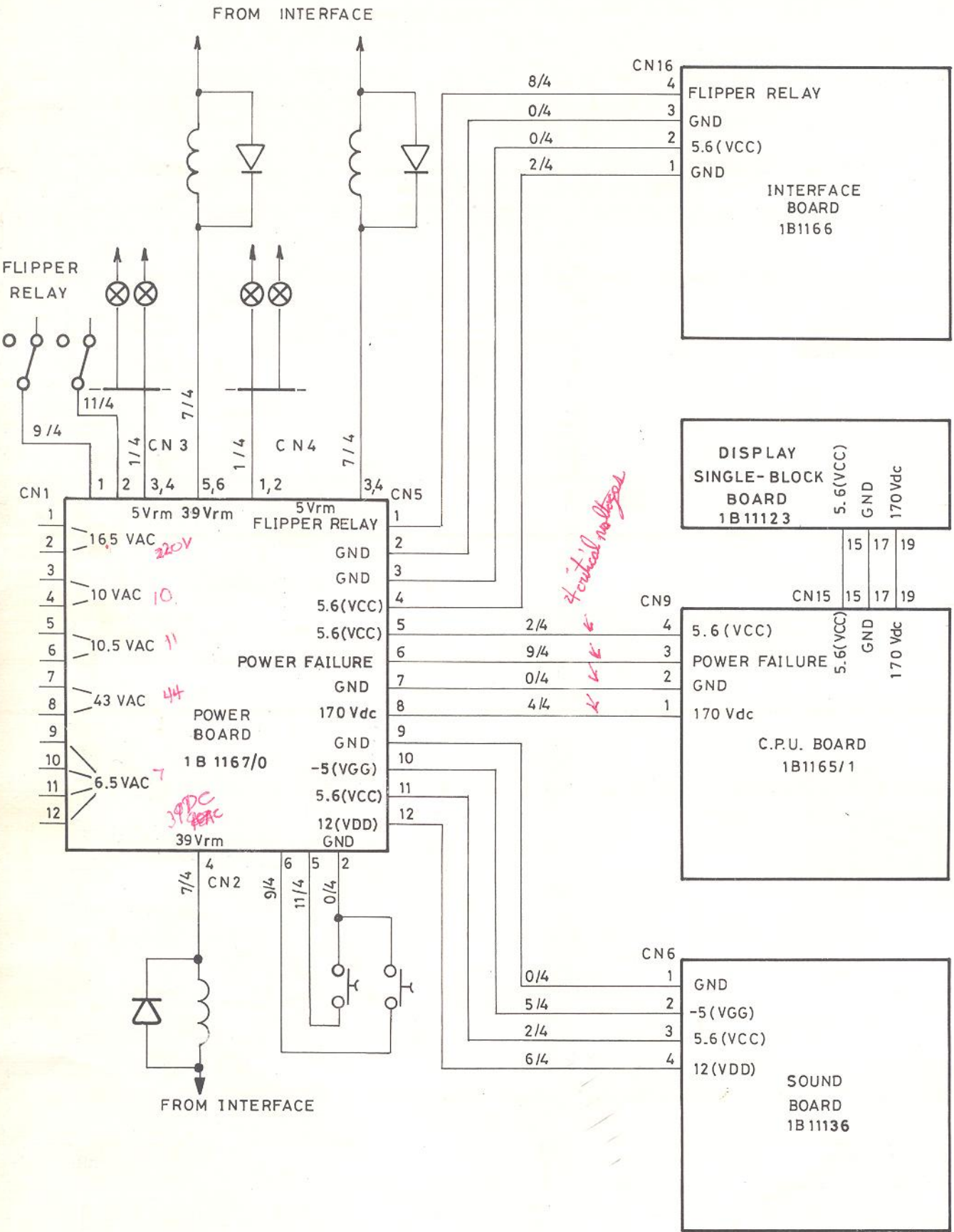

F.LI ZACCARIA s.n.c.
Via Armadori, 15 - 40012 CALDERARA DI RENO (Bo) Italy

PART NAME ELECTRICAL DIAGRAM				PART NO.	
POWER WIRING					
DWN. <i>Rod</i>	DATE 3/9/82	REV. <i>[Signature]</i>	DATE REV. 13/1/84	SHEET	
NOTES: UNLESS OTHERWISE SPECIFIED					
1) ALL RESISTORS VALUES IN -----					
2) ALL CAPACITORS VALUES IN -----					

ASSEMBLY DRAWING

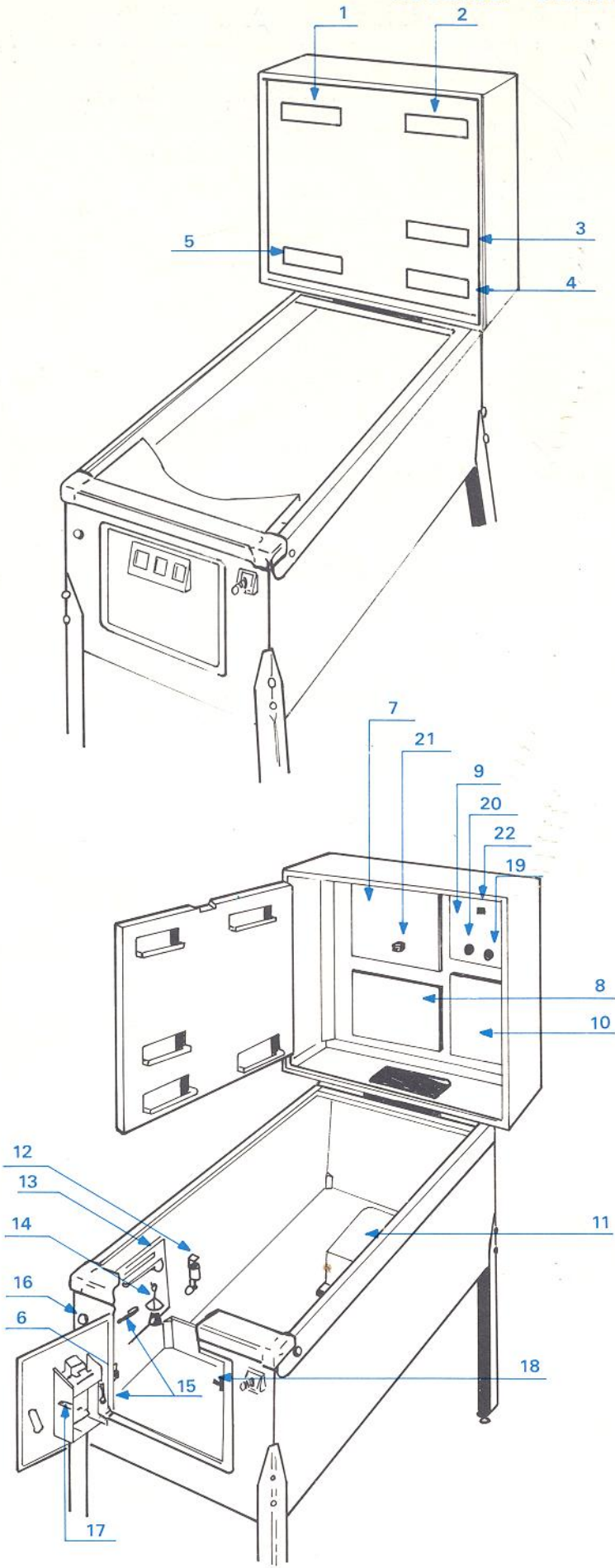

- 1. 1st player display
Highest score display
- 2. 2nd player display
- 3. Credit display
Display ball to play
Match
Game time bonus
- 4. 4th player display
- 5. 3rd player display

- 6. Service button
- 7. C.P.U. board
- 8. Interface board
- 9. Sound board
- 10. Power board
- 11. Transformer
- 12. Knocker
- 13. Roll ball tilt
- 14. Bob tilt
- 15. Antichoc tilt
- 16. Credit button
- 17. Advance & Return test
- 18. General vol.
- 19. Maximum speech vol.
- 20. Maximum sound vol.
- 21. Dip SWS
- 22. Sound self-test button

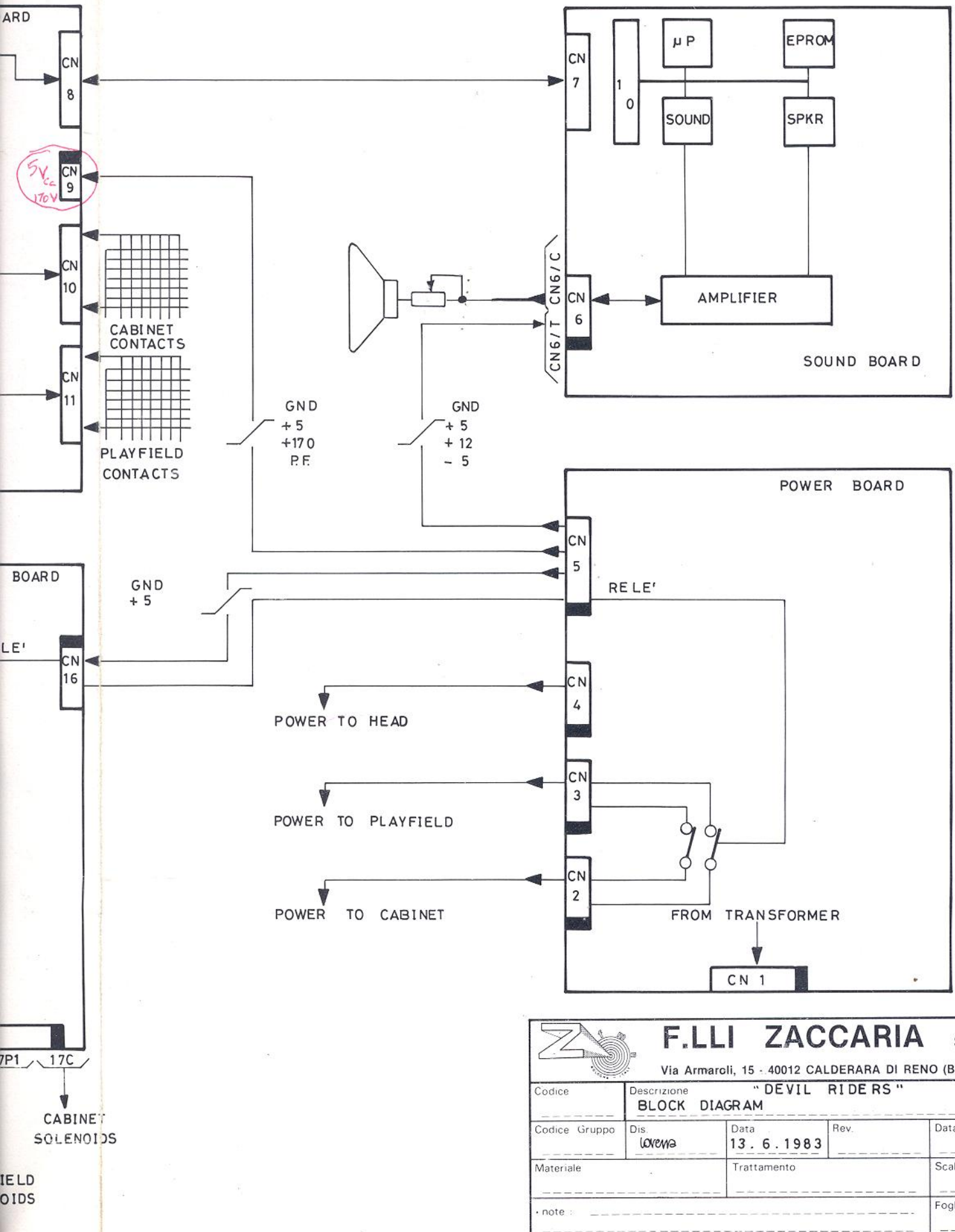

 F.LLI ZACCARIA s.n.c. Via Armaroli, 15 - 40012 CALDERARA DI RENO (Bo) ITALY		Descrizione "DEVIL RIDERS" BLOCK DIAGRAM		
		Codice		
Codice Gruppo	Dis. <i>Warena</i>	Data 13. 6. 1983	Rev.	Data Rev.
Materiale		Trattamento		Scala
note				Foglio

DRIVER DISPLAY BOARDS

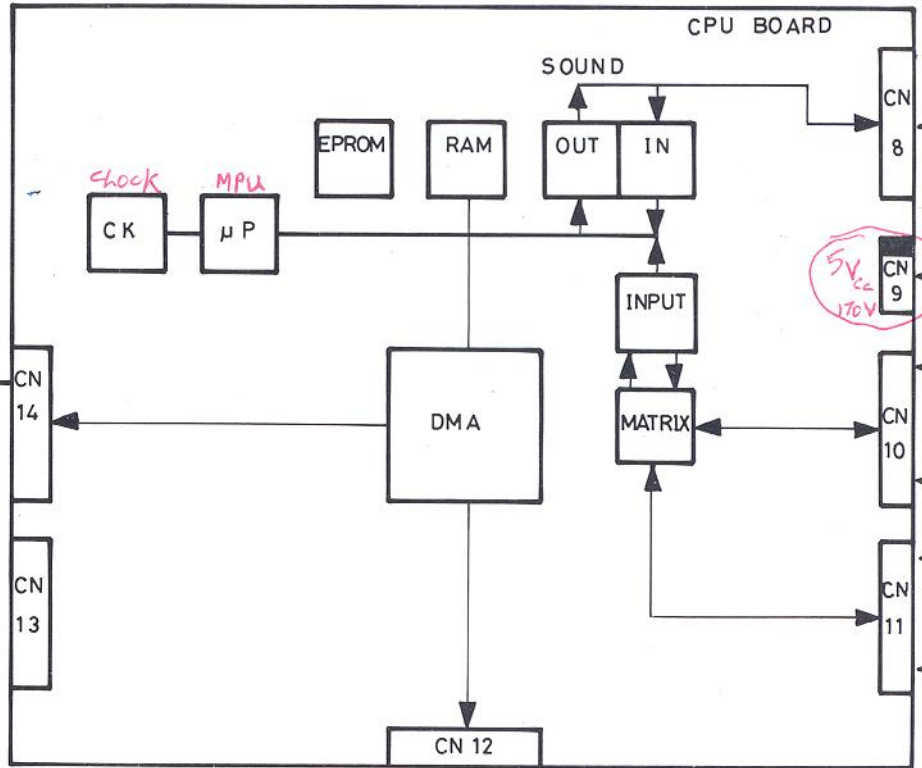
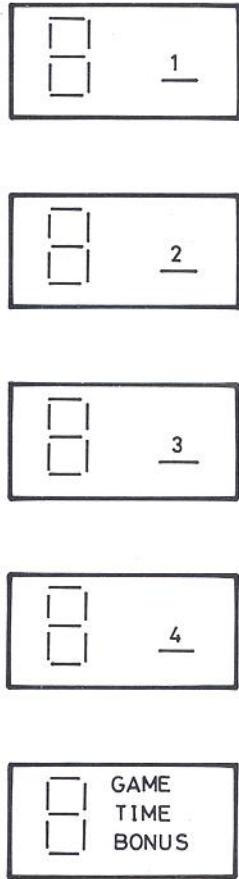

(HEAD SOLENOIDS)

HEAD LAMPS

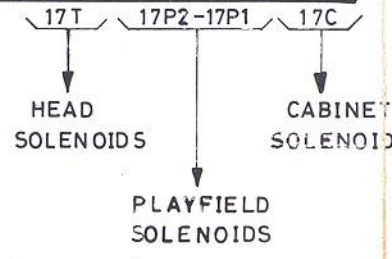
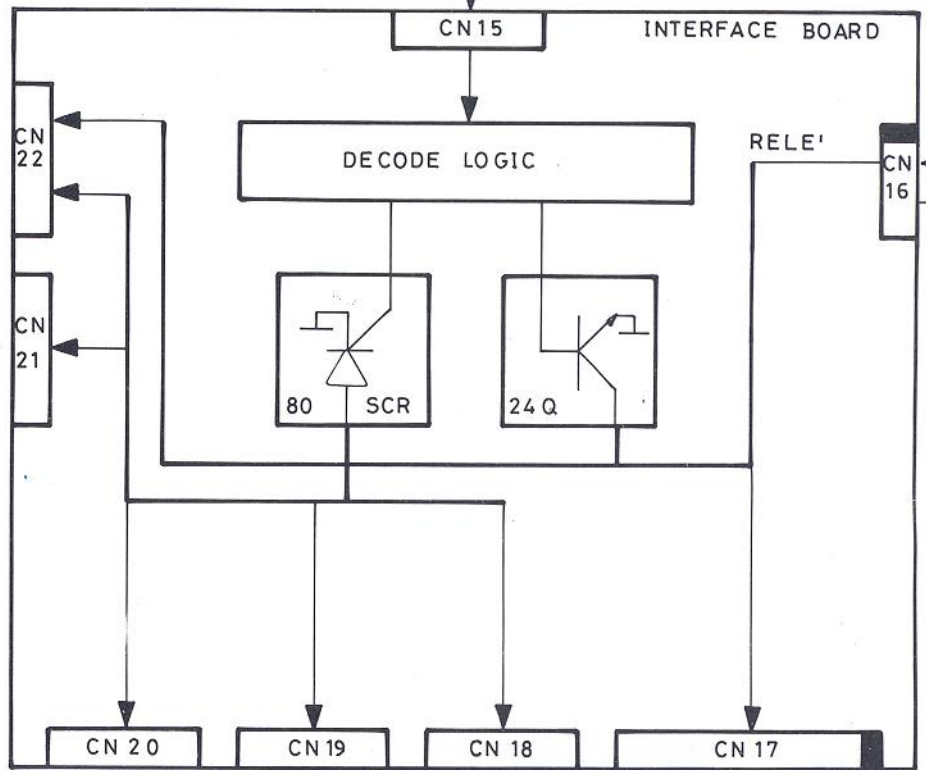

PLAYFIELD LAMPS

JUMP LIST FOR MEMORIES SELECTION

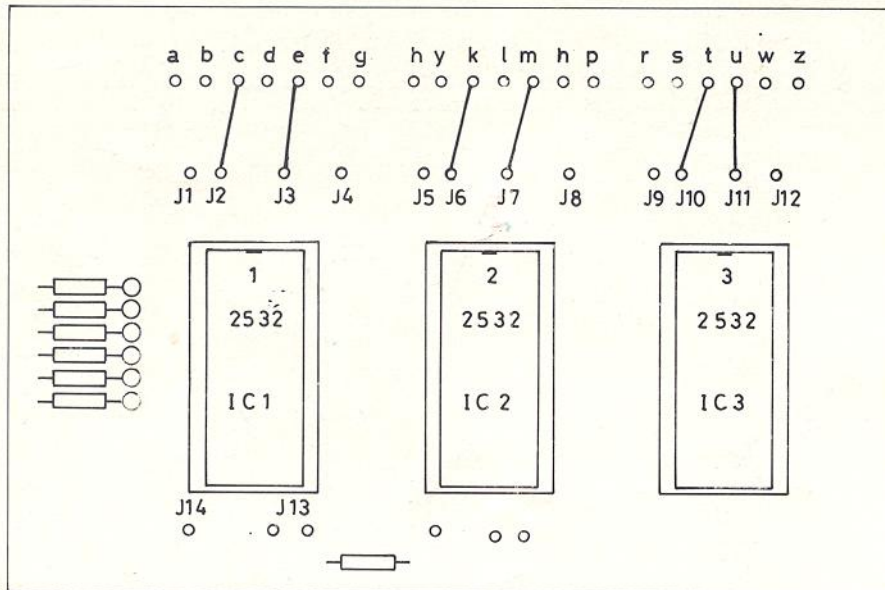

**PINBALL CHAMP
SOCCER KINGS
TIME MACHINE**

C.P.U.
PC. 1B1165 , 65/0 , 65/1

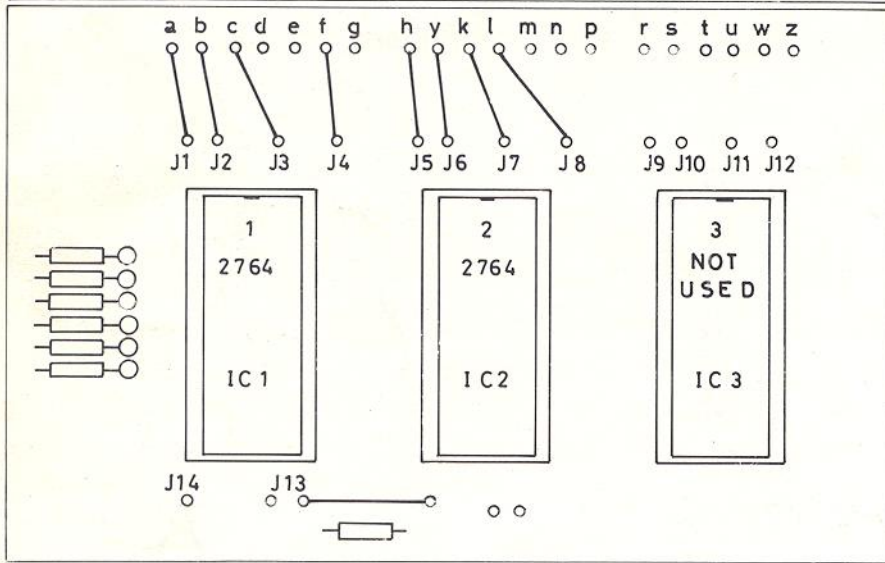

**FARFALLA
DEVIL RIDERS**

C.P.U.
PC. 1B1165 65/0 65/1

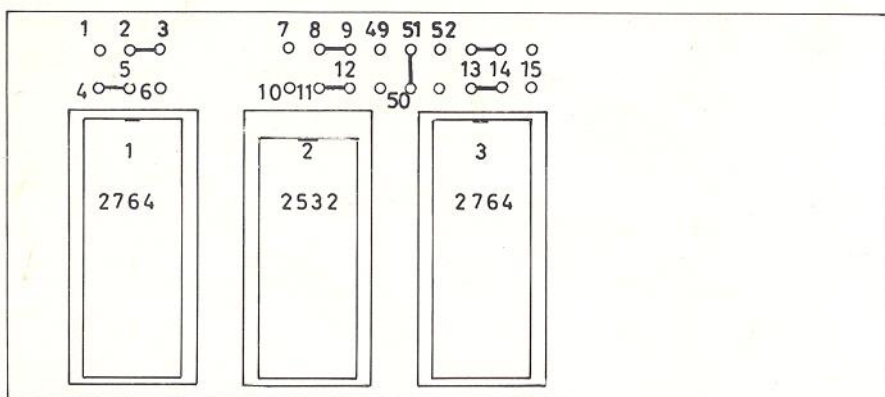

TIME MACHINE

SOUND
PC. 1B11136

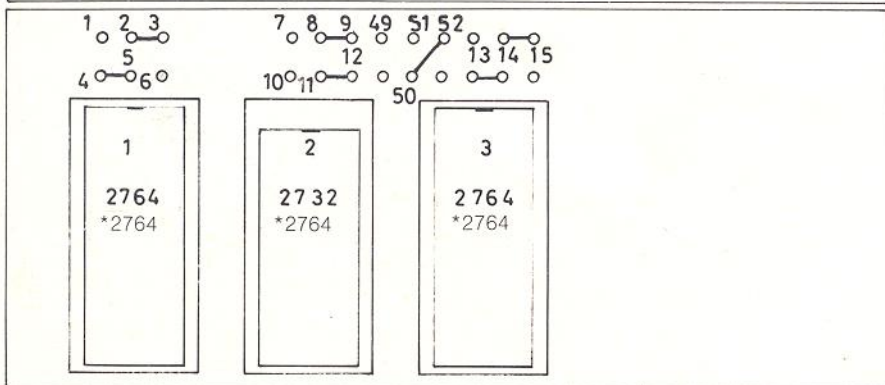

**FARFALLA
* DEVIL RIDERS
SOUND
PC. 1B11136**