

COMBAT

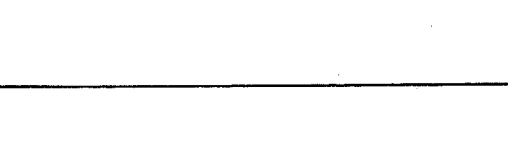
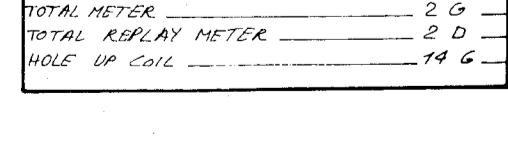
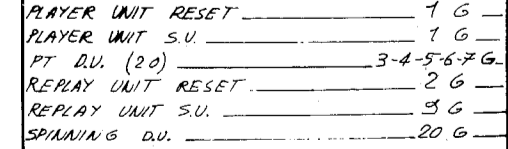
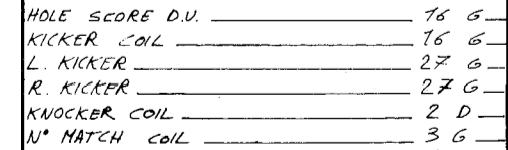
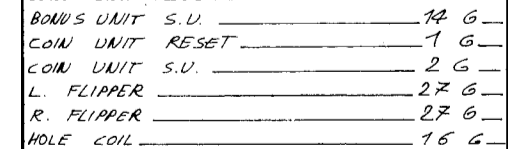
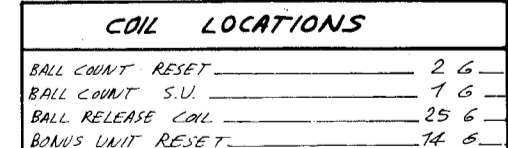
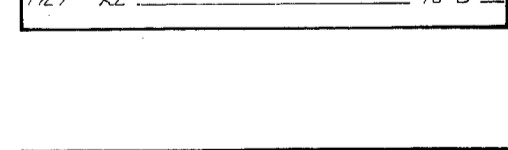
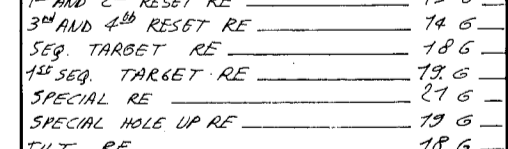
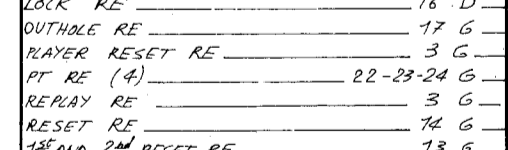
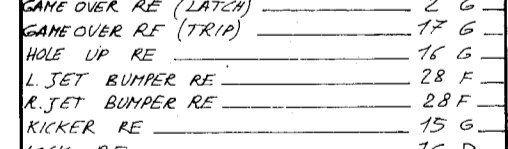
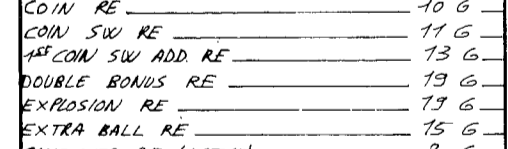
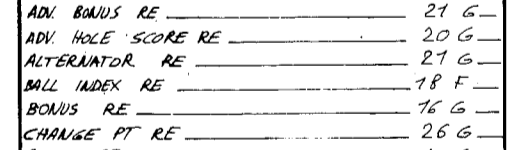
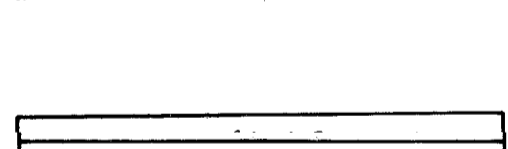
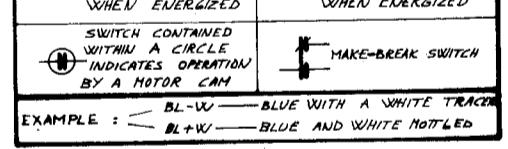
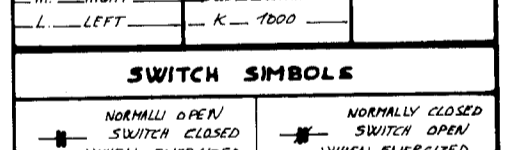
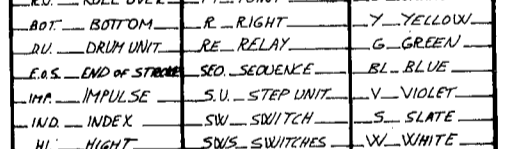
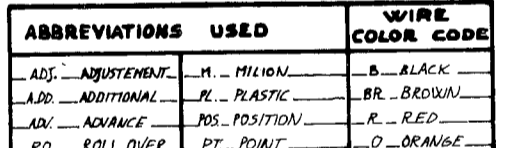
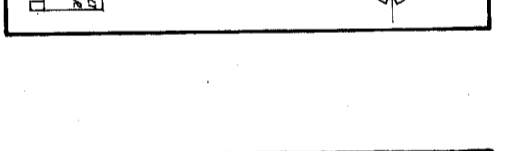
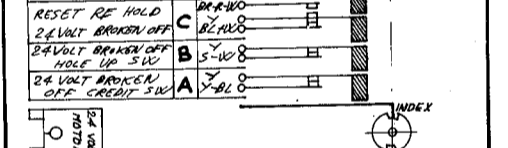
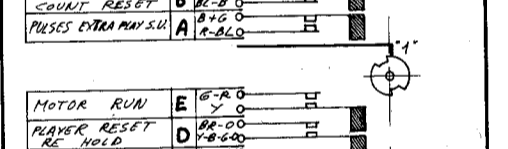
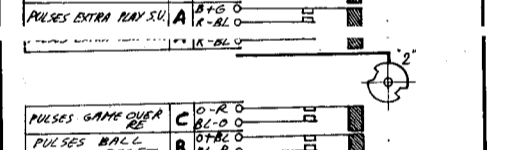
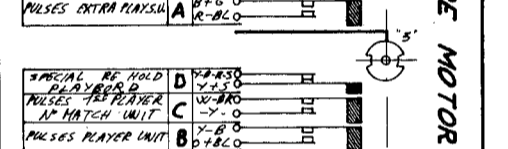
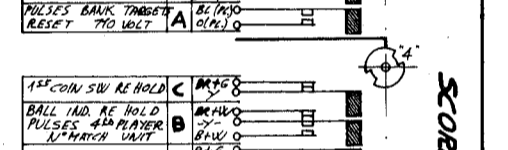
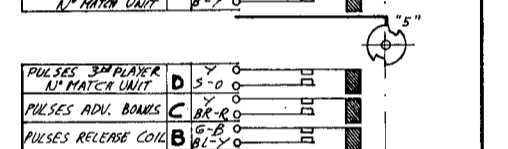
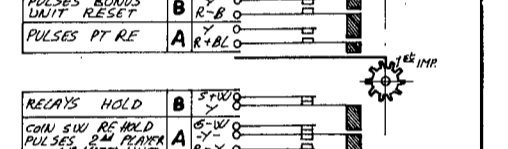
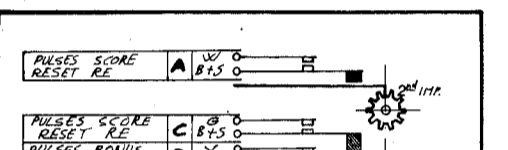
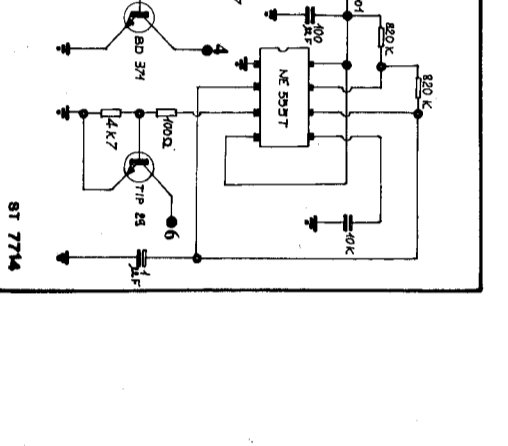
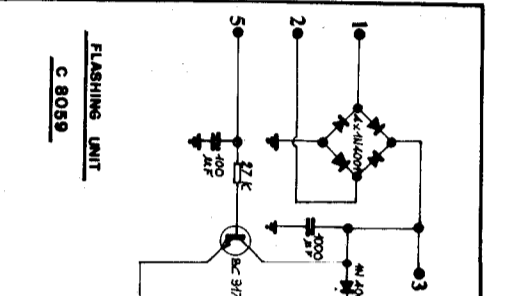
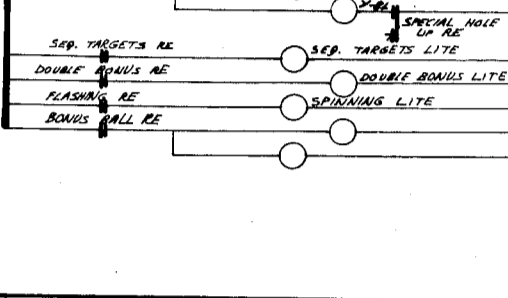
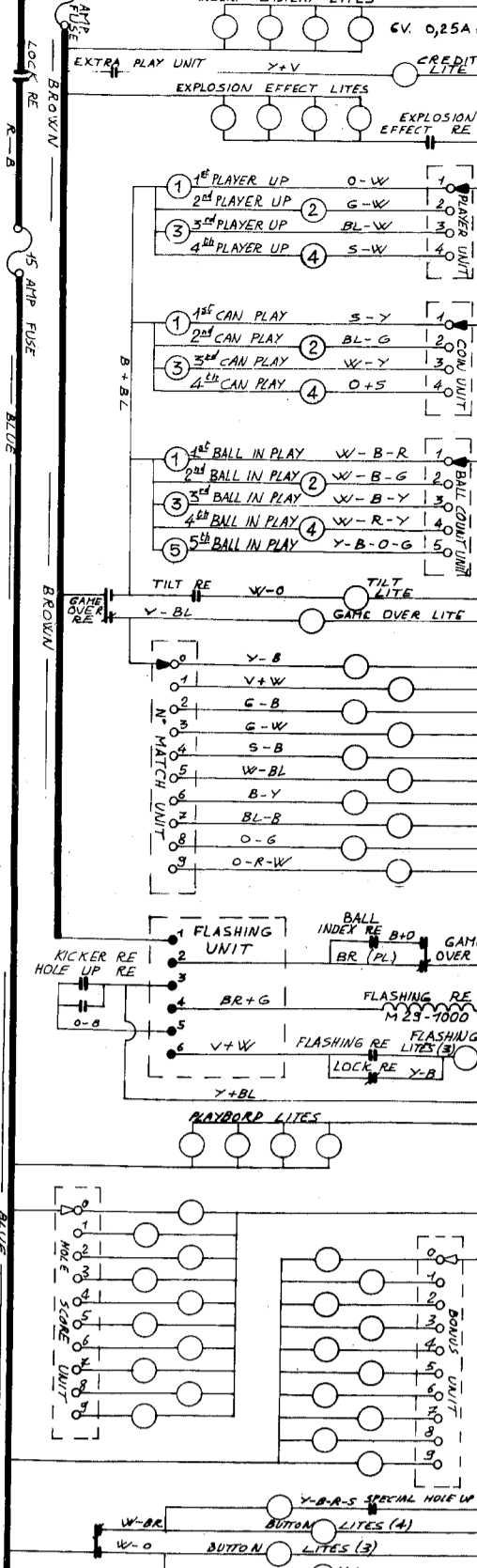
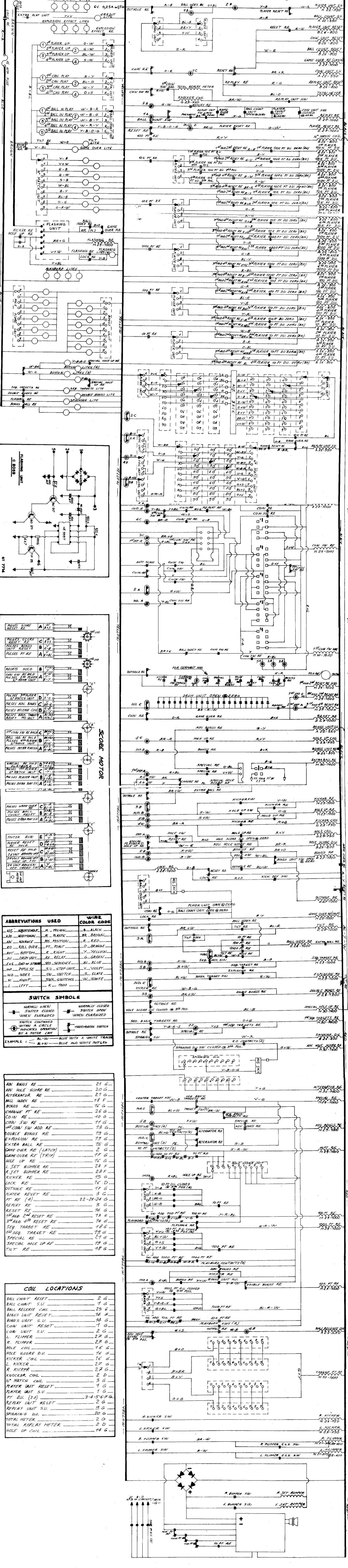

ABBREVIATIONS USED	WIRE COLOR CODE
ADJ. - ADJUSTMENT	M. - MILION
ADD. - ADDITIONAL	PL. - PLASTIC
ADV. - ADVANCE	POS. - POSITION
RO. - ROLL OVER	PT. - POINT
BOT. - BOTTOM	R. - RIGHT
DU. - DRUM UNIT	RE. - RELAY
EAS. - END OF STRIP	SEQ. - SEQUENCE
IMP. - IMPULSE	S.U. - STEP UNIT
IND. - INDEX	SW. - SWITCH
HI. - NIGHT	SW.S. - SWITCHES
L. - LEFT	K. - TROD

SWITCH SYMBOLS	DESCRIPTION
(Symbol)	NORMALLY OPEN SWITCH CLOSED WHEN ENERGIZED
(Symbol)	NORMALLY CLOSED SWITCH OPEN WHEN ENERGIZED
(Symbol)	SWITCH CONTAINED WITHIN A CIRCLE INDICATES OPERATION BY A MOTOR
(Symbol)	MAKE-BREAK SWITCH

EXAMPLE: BL-W - BLUE WITH A WHITE TRACKER
 BL+W - BLUE AND WHITE HOTLED

COIL LOCATIONS	LOCATION
BALL COUNT RESET	2 G
BALL COUNT S.U.	1 G
BALL RELEASE COIL	25 F
BONUS UNIT RESET	14 S
BONUS UNIT S.U.	14 G
COIN UNIT RESET	1 G
COIN UNIT S.U.	2 G
L. FLIPPER	27 G
R. FLIPPER	27 G
HOLE COIL	16 G
HOLE SCORE DU.	18 S
KICKER COIL	16 S
L. KICKER	27 G
R. KICKER	27 G
KNOCKER COIL	2 D
N° MATCH COIL	3 G
PLAYER UNIT RESET	1 G
PT DU. (20)	3-4-5-6 G
REPLAY UNIT RESET	28 F
REPLAY UNIT S.U.	3 G
SPINNING DU.	20 G
TOTAL METER	2 G
TOTAL REPLAY METER	2 D
HOLE UP COIL	14 G

